

# DATA 018 - CENOVNIK





NAPOMENA: Cene su u dinarima, sa uračunatim PDV-om.



23.05.2026 21:40

## Instalacioni kablovi - bakarni

### Cat.5 i Cat.5e

Proizvođač: Reichle & De-Massari







	Web šifra	Kat.oznaka	Naziv proizvoda	Jed.mere	PDV	Cena (din)
1) 	0000000001	R35044	Instalacioni kabl Cat.5e, U/UTP, 4P, 200MHz, PVC	m	20 %	50,59
2) 	0000000002	R35045	Instalacioni kabl Cat.5e, U/UTP, 4P, 200MHz, LSZH	m	20 %	56,54
3) 	0000000003	R35048	Instalacioni kabl Cat.5e, F/UTP, 4P, 200MHz, PVC	m	20 %	72,91
4) 	0000000004	R35049	Instalacioni kabl Cat.5e, F/UTP, 4P, 200MHz, LSZH	m	20 %	81,84





5)		0000001287 R302039	Instalacioni kabl Cat.5e, F/UTP, 4P, 200MHz, LSFRZH	m	20 %	104,16
6)		0000000005 R35052	Instalacioni kabl Cat.5e, SF/UTP, 4P, 200MHz, PVC	m	20 %	90,77
7)		0000001288 R302089	Instalacioni kabl Cat.5e, SF/UTP, 4P, 200MHz, LSZH	m	20 %	98,21
8)		0000000006 R35053	Instalacioni kabl Cat.5e, SF/UTP, 4P, 200MHz, LSFRZH	m	20 %	110,11

#### Cat.6 i Cat.6A

**Proizvođač: Reichle & De-Massari**

	Web šifra	Kat.oznaka	Naziv proizvoda	Jed.mere	PDV	Cena (din)
9)		0000000007 R35056	Instalacioni kabl Cat.6, U/UTP, 4P, 450MHz, PVC	m	20 %	74,40







10)		0000000008 R35057	Instalacioni kabl Cat.6, U/UTP, 4P, 450MHz, LSZH	m	20 %	83,33
11)		0000001432 R812526	Instalacioni kabl Cat.6, U/UTP, 4P, 450MHz, LSFRZH	m	20 %	117,55
12)		0000000009 R314933	Instalacioni kabl Cat.6, F/UTP, 4P, 450MHz, LSZH	m	20 %	111,60
13)		0000001433 R808400	Instalacioni kabl Cat.6A, U/UTP, 4P, 650MHz, LSZH	m	20 %	141,36
14)		0000001434 R804268	Instalacioni kabl Cat.6A, U/UTP, 4P, 650MHz, PVC, WARP	m	20 %	141,36
15)		0000001435 R804269	Instalacioni kabl Cat.6A, U/UTP, 4P, 650MHz, LSZH, WARP	m	20 %	144,34

16)		000000011 R308247	Instalacioni kabl Cat.6A, U/FTP, 4P, 650MHz, LSZH	m	20 %	104,16
17)		0000001436 R813847	Instalacioni kabl Cat.6A, U/FTP, 4P, 650MHz, LSFRZH	m	20 %	111,60
18)		000000013 R305649	Instalacioni kabl Cat.6A, S/FTP, 4P, 650MHz, LSZH	m	20 %	119,04
19)		0000001437 R310488	Instalacioni kabl Cat.6A, S/FTP, 4P, 650MHz, LSFRZH	m	20 %	132,43

**Cat.7 i Cat.7A**

**Proizvođač: Reichle & De-Massari**

	Web šifra	Kat.oznaka	Naziv proizvoda	Jed.mere	PDV	Cena (din)
20)		0000001284 R320249	Instalacioni kabl Cat.7, F/FTP, 4P, 650MHz, LSZH	m	20 %	108,62

21)		000000014 R35257	Instalacioni kabl Cat.7, S/FTP, 4P, 1000MHz, LSZH	m	20 %	122,02
22)		0000001285 R809799	Instalacioni kabl Cat.7, S/FTP, 4P, 1000MHz, LSFRZH	m	20 %	zvati
23)		0000001286 R35060	Instalacioni kabl Cat.7, S/FTP, 4P, 1000MHz, LSFRZH, smanjeno slabljenje	m	20 %	151,78
24)		0000001438 R809800	Instalacioni kabl Cat.7A, S/FTP, 4P, 1200MHz, LSZH	m	20 %	139,87
25)		0000000016 R319522	Instalacioni kabl Cat.7A, S/FTP, 4P, 1200MHz, LSFRZH	m	20 %	151,78
26)		0000000017 R306257	Instalacioni kabl Real10 Cat.7A, S/FTP, 4P, 1200MHz, LSFRZH	m	20 %	165,17

27)		000000018 R507032	Instalacioni kabl Cat.7A, S/FTP, 4P, 1500MHz, LSFRZH	m	20 %	191,95
-----	---	-------------------	--	---	------	--------

### Cat.8.2

Proizvođač: Reichle & De-Massari





	Web šifra	Kat.oznaka	Naziv proizvoda	Jed.mere	PDV	Cena (din)
28)		0000001555 R828594	Instalacioni kabl Cat.8.2, S/FTP, 4P, 2000MHz, LSFRZH	m	20 %	294,62





### Prespojni paneli

#### Prespojni paneli 1U, 16 portova

Proizvođač: Reichle & De-Massari

	Web šifra	Kat.oznaka	Naziv proizvoda	Jed.mere	PDV	Cena (din)
29)		0000000071 R305886	19 inc, 1U prespojni panel sa 16xRJ45/u, Cat.5e	kom	20 %	15.695,42







30)		000000072 R305885	19 inc, 1U prespojni panel sa 16xRJ45/s, Cat.5e	kom	20 %	19.010,69
31)		000000073 R305888	19 inc, 1U prespojni panel sa 16xRJ45/u, Cat.6	kom	20 %	15.260,93
32)		000000074 R313086	19 inc, 1U prespojni panel sa 16xRJ45/u, Real10 Cat.6	kom	20 %	15.963,26
33)		000000075 R305887	19 inc, 1U prespojni panel sa 16xRJ45/s, Real10 Cat.6	kom	20 %	21.817,06
34)		0000001400 R813523	19 inc, 1U prespojni panel sa 16xRJ45/u, Cat.6A EL	kom	20 %	12.610,80
35)		0000001399 R813522	19 inc, 1U prespojni panel sa 16xRJ45/s, Cat.6A EL	kom	20 %	23.848,18







36)		000000076 R509881	19 inc, 1U prespojni panel sa 16xRJ45/u, Cat.6A ISO	kom	20 %	20.323,10
37)		000000077 R509880	19 inc, 1U prespojni panel sa 16xRJ45/s, Cat.6A ISO	kom	20 %	27.042,91
38)		000000078 R305890	19 inc, 1U prespojni panel za 16xRJ45/u, bez modula	kom	20 %	6.440,06
39)		000000079 R305889	19 inc, 1U prespojni panel za 16xRJ45/s, bez modula	kom	20 %	9.300,00

**Prespojni paneli 1U, 24 porta ST**

**Proizvođač: Reichle & De-Massari**

	Web šifra	Kat.oznaka	Naziv proizvoda	Jed.mere	PDV	Cena (din)
40)		000000080 R305118	19 inc, 1U ST prespojni panel sa 24xRJ45/u, Cat.5e	kom	20 %	21.061,15







41)		000000081 R305121	19 inc, 1U ST prespojni panel sa 24xRJ45/s, Cat.5e	kom	20 %	26.748,29
42)		000000082 R305117	19 inc, 1U ST prespojni panel sa 24xRJ45/u, Cat.6, siv	kom	20 %	22.677,12
43)		000000083 R514696	19 inc, 1U ST prespojni panel sa 24xRJ45/u, Cat.6, crn	kom	20 %	22.677,12
44)		000000084 R313087	19 inc, 1U ST prespojni panel sa 24xRJ45/u, Real10 Cat.6, siv	kom	20 %	20.643,02
45)		000000085 R305120	19 inc, 1U ST prespojni panel sa 24xRJ45/s, Real10 Cat.6, siv	kom	20 %	28.426,75
46)		000000086 R514695	19 inc, 1U ST prespojni panel sa 24xRJ45/s, Real10 Cat.6, crn	kom	20 %	28.426,75







47)		000000087	R509883	19 inc, 1U ST prespojni panel sa 24xRJ45/u, Cat.6A ISO, siv	kom	20 %	29.640,96
48)		000000088	R514694	19 inc, 1U ST prespojni panel sa 24xRJ45/u, Cat.6A ISO, crn	kom	20 %	29.640,96
49)		000000089	R509882	19 inc, 1U ST prespojni panel sa 24xRJ45/s, Cat.6A ISO, siv	kom	20 %	35.872,70
50)		000000090	R514693	19 inc, 1U ST prespojni panel sa 24xRJ45/s, Cat.6A ISO, crn	kom	20 %	zvati
51)		000000091	R305119	19 inc, 1U ST prespojni panel za 24xRJ45 ili FO adaptere, siv, bez modula	kom	20 %	9.838,66
52)		000000092	R511996	19 inc, 1U ST prespojni panel za 24xRJ45 ili FO adaptere, crn, bez modula	kom	20 %	9.838,66







Prespojni panel, 1U, 24 porta PC

Proizvođač: Reichle & De-Massari

	Web šifra	Kat.oznaka	Naziv proizvoda	Jed.mere	PDV	Cena (din)
53)		0000001263 R812471	19 inc, 1U PC prespojni panel sa 24xRJ45/u, Cat.5e, siv	kom	20 %	17.853,02
54)		0000001265 R812469	19 inc, 1U PC prespojni panel sa 24xRJ45/u, Cat.5e, crn	kom	20 %	16.918,56
55)		0000001264 R812470	19 inc, 1U PC prespojni panel sa 24xRJ45/s, Cat.5e, siv	kom	20 %	23.754,43
56)		0000001266 R812468	19 inc, 1U PC prespojni panel sa 24xRJ45/s, Cat.5e, crn	kom	20 %	21.440,59
57)		0000001267 R812475	19 inc, 1U PC prespojni panel sa 24xRJ45/u, Cat.6, siv	kom	20 %	18.716,06

58)		0000001268 R812473	19 inc, 1U PC prespojni panel sa 24xRJ45/u, Cat.6, crn	kom	20 %	18.716,06
59)		0000001269 R812474	19 inc, 1U PC prespojni panel sa 24xRJ45/s, Real10 Cat.6, siv	kom	20 %	24.557,95
60)		0000001270 R812472	19 inc, 1U PC prespojni panel sa 24xRJ45/s, Real10 Cat.6, crn	kom	20 %	24.557,95
61)		0000001365 R813490	19 inc, 1U PC prespojni panel sa 24xRJ45/u, Cat.6A EL, siv	kom	20 %	21.726,29
62)		0000001366 R813488	19 inc, 1U PC prespojni panel sa 24xRJ45/u, Cat.6A EL, crn	kom	20 %	21.726,29
63)		0000001367 R813489	19 inc, 1U PC prespojni panel sa 24xRJ45/s, Cat.6A EL, siv	kom	20 %	28.292,83





64)		0000001368 R813487	19 inc, 1U PC prespojni panel sa 24xRJ45/s, Cat.6A EL, crn	kom	20 %	28.292,83
65)		0000001369 R813494	19 inc, 1U PC prespojni panel sa 24xRJ45/u, Cat.6A ISO, siv	kom	20 %	28.486,27
66)		0000001372 R813491	19 inc, 1U PC prespojni panel sa 24xRJ45/s, Cat.6A ISO, crn	kom	20 %	35.152,51
67)		0000001370 R813492	19 inc, 1U PC prespojni panel sa 24xRJ45/u, Cat.6A ISO, crn	kom	20 %	22.001,57
68)		0000001371 R813493	19 inc, 1U PC prespojni panel sa 24xRJ45/s, Cat.6A ISO, siv	kom	20 %	35.152,51
69)		0000001271 R812467	19 inc, 1U PC prespojni panel za 24xRJ45/u, Cat.5/6, siv, bez modula	kom	20 %	5.437,15

70)		0000001272	R812465	19 inc, 1U PC prespojni panel za 24xRJ45/u, Cat.5/6, crn, bez modula	kom	20 %	5.437,15
71)		0000001273	R812466	19 inc, 1U PC prespojni panel za 24xRJ45/s, Cat.5/6, siv, bez modula	kom	20 %	5.868,67
72)		0000001274	R812464	19 inc, 1U PC prespojni panel za 24xRJ45/s, Cat.5/6, crn, bez modula	kom	20 %	5.868,67
73)		0000001373	R813486	19 inc, 1U PC prespojni panel za 24xRJ45/u, Cat.6A, siv, bez modula	kom	20 %	6.008,54
74)		0000001402	R813484	19 inc, 1U PC prespojni panel za 24xRJ45/u, Cat.6A, crnv, bez modula	kom	20 %	6.008,54
75)		0000001374	R813485	19 inc, 1U PC prespojni panel za 24xRJ45/s, Cat.6A, siv, bez modula	kom	20 %	6.440,06







76)		0000001401 R813483	19 inc, 1U PC prespojni panel za 24xRJ45/s, Cat.6A, crn, bez modula	kom	20 %	6.440,06
-----	---	--------------------	---	-----	------	----------





**Prespojni panel, 1U, 48 portova, High Density**

**Proizvođač: Reichle & De-Massari**

	Web šifra	Kat.oznaka	Naziv proizvoda	Jed.mere	PDV	Cena (din)
77)		0000001304 R809210	19 inc, 1U HD osnovni prespojni panel sa 24xRJ45/u, Cat.5e, siv	kom	20 %	21.276,91
78)		0000001303 R809209	19 inc, 1U HD osnovni prespojni panel sa 24xRJ45/s, Cat.5e, siv	kom	20 %	26.804,83
79)		0000001305 R809214	19 inc, 1U HD osnovni prespojni panel sa 24xRJ45/u, Cat.6, siv	kom	20 %	21.669,74
80)		0000001302 R809213	19 inc, 1U HD osnovni prespojni panel sa 24xRJ45/s, Real10 Cat.6, siv	kom	20 %	27.294,38

81)		0000001306	R512425	19 inc, 1U HD osnovni prespojni panel sa 24xRJ45/u, Cat.6A ISO, siv	kom	20 %	29.590,37
82)		0000001403	R512730	19 inc, 1U HD osnovni prespojni panel sa 24xRJ45/u, Cat.6A ISO, crn	kom	20 %	29.590,37
83)		0000001301	R512424	19 inc, 1U HD osnovni prespojni panel sa 24xRJ45/s, Cat.6A ISO, siv	kom	20 %	48.877,82
84)		0000001420	R512729	19 inc, 1U HD osnovni prespojni panel sa 24xRJ45/s, Cat.6A ISO, crn	kom	20 %	35.521,54
85)		0000001307	R512423	19 inc, 1U HD osnovni prespojni panel sa 48xRJ45/u, Cat.6A ISO, siv	kom	20 %	61.021,39
86)		0000001405	R512728	19 inc, 1U HD osnovni prespojni panel sa 48xRJ45/u, Cat.6A ISO, crn	kom	20 %	49.133,76

87)		0000001308 R512422	19 inc, 1U HD osnovni prespojni panel sa 48xRJ45/s, Cat.6A ISO, siv	kom	20 %	82.402,46
88)		0000001404 R512727	19 inc, 1U HD osnovni prespojni panel sa 48xRJ45/s, Cat.6A ISO, crn	kom	20 %	59.883,07
89)		0000001309 R809218	19 inc, 1U HD prespojni panel sa 24xRJ45/u, Cat.5e, siv	kom	20 %	23.038,70
90)		0000001310 R809217	19 inc, 1U HD prespojni panel sa 24xRJ45/s, Cat.5e, siv	kom	20 %	29.036,83
91)		0000001311 R809222	19 inc, 1U HD prespojni panel sa 24xRJ45/u, Cat.6, siv	kom	20 %	29.091,89
92)		0000001312 R809221	19 inc, 1U HD prespojni panel sa 24xRJ45/u, Cat.6, siv	kom	20 %	39.768,29

93)		0000001313 R512420	19 inc, 1U HD prespojni panel sa 24xRJ45/u, Cat.6A ISO, siv	kom	20 %	39.521,28
94)		0000001408 R512725	19 inc, 1U HD prespojni panel sa 24xRJ45/u, Cat.6A ISO, crn	kom	20 %	31.822,37
95)		0000001314 R512419	19 inc, 1U HD prespojni panel sa 24xRJ45/s, Cat.6A ISO, siv	kom	20 %	51.949,06
96)		0000001407 R512724	19 inc, 1U HD prespojni panel sa 24xRJ45/s, Cat.6A ISO, crn	kom	20 %	51.949,06
97)		0000001315 R512418	19 inc, 1U HD prespojni panel sa 48xRJ45/u, Cat.6A ISO, siv	kom	20 %	70.682,98
98)		0000001410 R512723	19 inc, 1U HD prespojni panel sa 48xRJ45/u, Cat.6A ISO, crn	kom	20 %	68.259,02

99)		0000001316 R512417	19 inc, 1U HD prespojni panel sa 48xRJ45/s, Cat.6A ISO, siv	kom	20 %	85.473,70
100)		0000001409 R512722	19 inc, 1U HD prespojni panel sa 48xRJ45/s, Cat.6A ISO, crn	kom	20 %	85.473,70
101)		0000001317 R512421	19 inc, 1U HD osnovni prespojni panel do 48 portova, bez modula, siv	kom	20 %	7.154,30
102)		0000001406 R512726	19 inc, 1U HD osnovni prespojni panel do 48 portova, bez modula, crn	kom	20 %	7.154,30
103)		0000001300 R512416	19 inc, 1U HD prespojni panel do 48 portova, bez modula, siv	kom	20 %	10.017,22
104)		0000001411 R512721	19 inc, 1U HD prespojni panel do 48 portova, bez modula, crn	kom	20 %	10.017,22

105)		0000001318	R809339	6-to portni držač modula za HD prespojne panele, neširmovan, za Cat.5/6, siv, 4 komada	kom	20 %	7.154,30
106)		0000001415	R809341	6-to portni držač modula za HD prespojne panele, neširmovan, za Cat.5/6, crn, 4 komada	kom	20 %	8.585,76
107)		0000001319	R809225	6-to portni držač modula za HD prespojne panele, širmovan, za Cat.5/6, siv, 4 komada	kom	20 %	8.585,76
108)		0000001413	R809340	6-to portni držač modula za HD prespojne panele, širmovan, za Cat.5/6, crn, 4 komada	kom	20 %	8.585,76
109)		0000001320	R512429	6-to portni držač modula za HD prespojne panele, neširmovan, za Cat.6A ISO sa slepim poljem, siv, 4 komada	kom	20 %	8.585,76
110)		0000001414	R512734	6-to portni držač modula za HD prespojne panele, neširmovan, za Cat.6A ISO sa slepim poljem, crn, 4 komada	kom	20 %	8.585,76

111)		0000001321	R512427	6-to portni držač modula za HD prespojne panele, širmovan, za Cat.6A ISO sa slepim poljem, siv, 4 komada	kom	20 %	10.017,22
112)		0000001412	R512732	6-to portni držač modula za HD prespojne panele, širmovan, za Cat.6A ISO sa slepim poljem, crn, 4 komada	kom	20 %	10.017,22
113)		0000001322	R512428	12-to portni držač modula za HD prespojne panele, neširmovan, za Cat.6A ISO, siv, 4 komada	kom	20 %	11.445,70
114)		0000001417	R512733	12-to portni držač modula za HD prespojne panele, neširmovan, za Cat.6A ISO, crn, 4 komada	kom	20 %	11.445,70
115)		0000001323	R512426	12-to portni držač modula za HD prespojne panele, širmovan, za Cat.6A ISO, siv, 4 komada	kom	20 %	12.880,13
116)		0000001416	R512731	12-to portni držač modula za HD prespojne panele, širmovan, za Cat.6A ISO, crn, 4 komada	kom	20 %	12.880,13







117)		0000001324 R512700	Kit za proširenje kapaciteta HD prespojnih panela, neširmovan	kom	20 %	5.022,00
118)		0000001325 R512431	Kit za proširenje kapaciteta HD prespojnih panela, širmovan	kom	20 %	5.022,00
119)		0000001326 R802922	Slepo polje za HD prespojne panele, siv	kom	20 %	2.889,70
120)		0000001418 R802923	Slepo polje za HD prespojne panele, crn	kom	20 %	2.889,70
121)		0000001419 R512430	Maska za obeležavanje	kom	20 %	288,67

**Prespojni paneli 2U, 48 portova, Global**

**Proizvođač: Reichle & De-Massari**

Web šifra	Kat.oznaka	Naziv proizvoda	Jed.mere	PDV	Cena (din)
-----------	------------	-----------------	----------	-----	------------





122)		0000000186	R505716	19 inc, 2U prespojni panel sa 48xRJ45/u, Cat.5e, Global	kom	20 %	32.185,44
123)		0000000187	R505715	19 inc, 2U prespojni panel sa 48xRJ45/s, Cat.5e, Global	kom	20 %	45.053,66
124)		0000000188	R505718	19 inc, 2U prespojni panel sa 48xRJ45/u, Cat.6, Global	kom	20 %	42.672,86
125)		0000000190	R505719	19 inc, 2U prespojni panel sa 48xRJ45/s, Real10 Cat.6, Global	kom	20 %	60.388,99
126)		0000001421	R813534	19 inc, 2U prespojni panel sa 48xRJ45/u, Cat.6A EL, Global	kom	20 %	48.266,26
127)		0000001422	R813533	19 inc, 2U prespojni panel sa 48xRJ45/s, Cat.6A EL, Global	kom	20 %	67.925,71

128)		0000000191 R509887	19 inc, 2U prespojni panel sa 48xRJ45/u, Cat.6A ISO, Global	kom	20 %	47.236,56
129)		0000000192 R509886	19 inc, 2U prespojni panel sa 48xRJ45/s, Cat.6A ISO, Global	kom	20 %	80.420,45
130)		0000000193 R503805	19 inc, 2U prespojni panel za 48xRJ45/u modula, bez modula, Global	kom	20 %	9.300,00
131)		0000000194 R503806	19 inc, 2U prespojni panel za 48xRJ45/s modula, bez modula, Global	kom	20 %	11.445,70
132)		0000000195 R504610	Držač modula, neširmovan, za 2U Global prespojne panele	kom	20 %	431,52
133)		0000000196 R503813	Držač modula, širmovan, za 2U Global prespojne panele	kom	20 %	714,24







134)		0000000197 R316871	Slepo polje za 2U Global prespojine panele	kom	20 %	577,34
------	---	--------------------	--	-----	------	--------







**Prespojni paneli 3U, 60 portova, Global**

**Proizvođač: Reichle & De-Massari**

	Web šifra	Kat.oznaka	Naziv proizvoda	Jed.mere	PDV	Cena (din)
135)		0000000200 R35405	19 inc, 3U prespojni panel sa 48xRJ45/u, Cat.5e, Global	kom	20 %	43.784,40
136)		0000000201 R35404	19 inc, 3U prespojni panel sa 48xRJ45/s, Cat.5e, Global	kom	20 %	60.388,99
137)		0000000198 R35407	19 inc, 3U prespojni panel sa 60xRJ45/u, Cat.5e, Global	kom	20 %	49.169,47
138)		0000000199 R35406	19 inc, 3U prespojni panel sa 60xRJ45/s, Cat.5e, Global	kom	20 %	66.791,86





139)		000000202 R302361	19 inc, 3U prespojni panel sa 48xRJ45/u, Cat.6, Global	kom	20 %	44.686,13
140)		000000203 R302363	19 inc, 3U prespojni panel sa 60xRJ45/u, Cat.6, Global	kom	20 %	56.838,62
141)		000000205 R302360	19 inc, 3U prespojni panel sa 48xRJ45/s, Real10 Cat.6, Global	kom	20 %	65.763,65
142)		000000207 R302362	19 inc, 3U prespojni panel sa 60xRJ45/s, Real10 Cat.6, Global	kom	20 %	76.617,12
143)		0000001425 R813536	19 inc, 3U prespojni panel sa 60xRJ45/u, Cat.6A EL, Global	kom	20 %	50.017,63
144)		0000001426 R813535	19 inc, 3U prespojni panel sa 60xRJ45/s, Cat.6A EL, Global	kom	20 %	86.025,74

145)		0000000208	R509889	19 inc, 3U prespojni panel sa 48xRJ45/u, Cat.6A ISO, Global	kom	20 %	52.627,58
146)		0000000209	R509888	19 inc, 3U prespojni panel sa 48xRJ45/s, Cat.6A ISO, Global	kom	20 %	73.746,77
147)		0000000210	R509891	19 inc, 3U prespojni panel sa 60xRJ45/u, Cat.6A ISO, Global	kom	20 %	61.802,59
148)		0000000211	R509890	19 inc, 3U prespojni panel sa 60xRJ45/s, Cat.6A ISO, Global	kom	20 %	101.663,14
149)		0000000212	R35409	19 inc, 3U prespojni panel za 60xRJ45/u modula, bez modula, Global	kom	20 %	10.439,81
150)		0000000213	R35408	19 inc, 3U prespojni panel za 60xRJ45/s modula, bez modula, Global	kom	20 %	12.142,08

151)		0000001427	R925861	Kit za uzemljenje za prespojne panele 3U, Global	kom	20 %	6.133,54
152)		0000000214	R35403	Držač modula, neširmovan, za 3U Global prespojne panele, širina 1GU	kom	20 %	886,85
153)		0000000215	R35402	Držač modula, širmovan, za 3U Global prespojne panele, širina 1GU	kom	20 %	1.172,54
154)		0000000216	R310400	Adapter za PBX spojne module 10xRJ45/u, širina 3GU	kom	20 %	1.876,37
155)		0000000217	R35401	Slepo polje za 3U Global prespojne panele, širina 1GU	kom	20 %	672,58
156)		0000000218	R302149	Slepo polje za 3U Global prespojne panele, širina 0.5GU	kom	20 %	672,58

## Voice paneli





Proizvođač: Reichle & De-Massari



	Web šifra	Kat.oznaka	Naziv proizvoda	Jed.mere	PDV	Cena (din)
157)	 000000093	R35115	19 inc, 1U prespojni panel za 50xRJ45/u, bez modula	kom	20 %	9.558,91
158)	 0000001428	R170668	19 inc, 1U voice panel sa 30xRJ45/u modula (4-5, 3-6)	kom	20 %	zvati
159)	 0000001423	R35117	Slepo polje za voice panel	kom	20 %	577,34
160)	 0000001424	R35118	Polica za voice panel	kom	20 %	17.338,18

## Spojni moduli i konektori

### RJ45 spojni moduli Cat.5e



Proizvođač: Reichle & De-Massari

		Web šifra	Kat.oznaka	Naziv proizvoda	Jed.mere	PDV	Cena (din)
161)		000000019	R925371	Spojni modul za utičnicu, 1xRJ45/u, Cat.5e	kom	20 %	538,66
162)		000000021	R925370	Spojni modul za utičnicu, 1xRJ45/s, Cat.5e	kom	20 %	758,88
163)		000000023	R302518	Spojni modul za prespojni panel, 1xRJ45/u, Cat.5e	kom	20 %	559,49
164)		000000025	R302780	Spojni modul za prespojni panel, 1xRJ45/s, Cat. 5e	kom	20 %	791,62
165)		000000027	R305112	Spojni modul 1xRJ45/u, Cat. 5e, Special	kom	20 %	538,66



166)		000000028	R305111	Spojni modul 1xRJ45/s, Cat. 5e, Special	kom	20 %	758,88
167)		000000029	R305764	Spojni modul 1xRJ45/s, Cat. 5e, Flap Jack	kom	20 %	812,45

### RJ45 spojni moduli Cat.6 i Real10 Cat.6

**Proizvođač: Reichle & De-Massari**



		Web šifra	Kat.oznaka	Naziv proizvoda	Jed.mere	PDV	Cena (din)
168)		000000034	R302373	Spojni modul za utičnicu, 1xRJ45/u, Cat.6	kom	20 %	580,32
169)		000000037	R304374	Spojni modul za prespojni panel, 1xRJ45/u, Cat.6	kom	20 %	604,13
170)		000000039	R305114	Spojni modul 1xRJ45/u, Cat.6, Special	kom	20 %	580,32

171)		000000030	R313064	Spojni modul za utičnicu, 1xRJ45/u, Real10 Cat.6	kom	20 %	507,41
172)		000000032	R302372	Spojni modul za utičnicu, 1xRJ45/s, Real10 Cat.6	kom	20 %	815,42
173)		000000040	R313090	Spojni modul za prespojni panel, 1xRJ45/u, Real10 Cat.6	kom	20 %	642,82
174)		000000042	R304373	Spojni modul za prespojni panel, 1xRJ45/s, Real10 Cat.6	kom	20 %	851,14
175)		000000044	R313084	Spojni modul 1xRJ45/u, Real10 Cat.6, Special	kom	20 %	578,83
176)		000000045	R305113	Spojni modul 1xRJ45/s, Real10 Cat.6, Special	kom	20 %	815,42

177)		000000047	R313103	Spojni modul 1xRJ45/u, Real10 Cat.6, Flap Jack	kom	20 %	517,82
178)		000000046	R305764	Spojni modul 1xRJ45/s, Real10 Cat.6, Flap Jack	kom	20 %	812,45

### RJ45 spojni moduli Cat.6A EL

**Proizvođač: Reichle & De-Massari**





		Web šifra	Kat.oznaka	Naziv proizvoda	Jed.mere	PDV	Cena (din)
179)		0000001347	R813506	Spojni modul za utičnicu, 1xRJ45/u, Cat.6A EL	kom	20 %	705,31
180)		0000001349	R813504	Spojni modul za utičnicu, 1xRJ45/s, Cat.6A EL	kom	20 %	979,10
181)		0000001351	R813518	Spojni modul za prespojni panel, 1xRJ45/u, Cat.6A EL	kom	20 %	718,70





182)		0000001353	R813516	Spojni modul za prespojni panel, 1xRJ45/s, Cat.6A EL	kom	20 %	1.005,89
183)		0000001355	R813510	Spojni modul, 1xRJ45/u, Cat.6A EL, Special	kom	20 %	677,04
184)		0000001357	R813508	Spojni modul, 1xRJ45/s, Cat.6A EL, Special	kom	20 %	934,46
185)		0000001359	R813514	Spojni modul, 1xRJ45/u, Cat.6A EL, Keystone	kom	20 %	733,58
186)		0000001361	R813512	Spojni modul, 1xRJ45/s, Cat.6A EL, Keystone	kom	20 %	1.019,28
187)		0000001363	R813521	Spojni modul, 1xRJ45/u, Cat.6A EL, Adapter No.1	kom	20 %	733,58

188)		0000001364 R813520	Spojni modul, 1xRJ45/s, Cat.6A EL, Adapter No.1	kom	20 %	1.019,28
------	---	--------------------	---	-----	------	----------

### RJ45 spojni moduli Cat.6A ISO

Proizvođač: Reichle & De-Massari

		Web šifra	Kat.oznaka	Naziv proizvoda	Jed.mere	PDV	Cena (din)
189)		0000000048	R509500	Spojni modul za utičnicu, 1xRJ45/u, Cat.6A ISO	kom	20 %	967,20
190)		0000000050	R509504	Spojni modul za utičnicu, 1xRJ45/s, Cat.6A ISO	kom	20 %	1.229,09
191)		0000000052	R509502	Spojni modul za prespojni panel, 1xRJ45/u, Cat.6A ISO	kom	20 %	967,20
192)		0000000054	R509506	Spojni modul za prespojni panel, 1xRJ45/s, Cat.6A ISO	kom	20 %	1.229,09





193)		0000000056	R803926	Spojni modul 1xRJ45/u, Cat.6A ISO, Special	kom	20 %	952,32
194)		0000000058	R803927	Spojni modul 1xRJ45/s, Cat.6A ISO, Special	kom	20 %	1.214,21
195)		0000000060	R509508	Spojni modul, 1xRJ45/u, Cat.6A ISO, Keystone	kom	20 %	993,98
196)		0000000061	R509509	Spojni modul, 1xRJ45/s, Cat.6A ISO, Keystone	kom	20 %	1.285,63

#### RJ45 FM konektori

Proizvođač: Reichle & De-Massari

	Web šifra	Kat.oznaka	Naziv proizvoda	Jed.mere	PDV	Cena (din)	
197)		0000000062	R312231	FM45 Modul Cat.5e, 4P, TIA568A/B (AWG26-23), IP20	kom	20 %	1.312,42

198)		0000000064	R510667	FM45 Modul Cat.5e, 4P, TIA568A/B (AWG23-22), IP20	kom	20 %	1.312,42
199)		0000000066	R803498	FM45 Modul pod uglom Cat.5e, 4P, TIA568A/B (AWG26-23), IP20	kom	20 %	1.190,40
200)		0000000067	R314686	FM45 Modul Cat.5e, 4P, TIA568A/B (AWG26-23), IP67, tip 06	kom	20 %	2.758,75
201)		0000001429	R815651	FM45 Modul Cat.6A, 4P, TIA568A/B (AWG26-22), IP20	kom	20 %	1.532,64
202)		0000001430	R814567	FM45 Modul Cat.6A, 4P, TIA568A/B (AWG26-22), IP20, metalno kućište	kom	20 %	1.743,94
203)		0000001469	R845599	FM45 Modul pod uglom Cat.6A, 4P, TIA568A/B (AWG26-23), IP20	kom	20 %	1.407,65



204)		0000001470	R814568	FM45 Modul Cat.6A, 4P, TIA568A/B (AWG26-22), IP67, tip 06	kom	20 %	2.758,75
205)		0000001561	R888230	FM45 EL Modul Cat.6A, širmovan/neširmovan, AWG (22-26), IP20, metalno kućište	kom	20 %	1.422,53
206)		0000001562	R836543	FM45 EL Modul Cat.6A slim, širmovan/neširmovan, AWG (22-26), IP20, metalno kućište	kom	20 %	1.547,52
207)		0000001563	R886069	FM45 EL Modul Cat.6A pod uglom, širmovan/neširmovan, AWG (22-26), IP20, metalno kućište	kom	20 %	1.961,18

### Spojnice za RJ45 konektore

Proizvođač: Reichle & De-Massari

	Web šifra	Kat.oznaka	Naziv proizvoda	Jed.mere	PDV	Cena (din)	
208)		0000001386	R307301	Spojnica Cat.5e/s za RJ45 konektor	kom	20 %	2.220,10

209)		0000001381	R509088	Spojnica Cat.6/u za RJ45 konektor	kom	20 %	1.992,43
210)		0000001382	R509091	Spojnica Cat.6/u za RJ45 konektor, Snap-in	kom	20 %	1.897,20
211)		0000001383	R509092	Spojnica Cat.6/u za RJ45 konektor, Adapter No. 1	kom	20 %	1.897,20
212)		0000001384	R509089	Spojnica Cat.6/u za RJ45 konektor, Keystone	kom	20 %	1.897,20
213)		0000001385	R509090	Spojnica Cat.6/s za RJ45 konektor, Special	kom	20 %	2.467,10
214)		0000001377	R509100	Spojnica Cat.6/s za RJ45 konektor	kom	20 %	1.449,31

215)		0000001376	R509115	Spojnica Cat.6/s za RJ45 konektor, Snap-in	kom	20 %	2.176,94
216)		0000001378	R509087	Spojnica Cat.6/s za RJ45 konektor, Adapter No. 1	kom	20 %	2.176,94
217)		0000001379	R509113	Spojnica Cat.6/s za RJ45 konektor, Keystone	kom	20 %	2.833,15
218)		0000001380	R509114	Spojnica Cat.6/s za RJ45 konektor, Special	kom	20 %	2.176,94

**Spojnice za bakarne kablove**



**Proizvođač: Reichle & De-Massari**

	<b>Web šifra</b>	<b>Kat.oznaka</b>	<b>Naziv proizvoda</b>	<b>Jed.mere</b>	<b>PDV</b>	<b>Cena (din)</b>	
219)		0000001171	R313356	Spojnica za bakarni kabl, Cat.6/s	kom	20 %	2.693,28

220)		0000001375 R812787	Spojnica za bakarni kabl, Cat.6A/s	kom	20 %	2.904,58
------	---	--------------------	------------------------------------	-----	------	----------

### PBX spojni moduli (RJ45)





Proizvođač: Reichle & De-Massari



	Web šifra	Kat.oznaka	Naziv proizvoda	Jed.mere	PDV	Cena (din)
221)		0000000068 R35116	PBX spojni modula za voice panel, 10xRJ45/u, (4-5, 3-6)	kom	20 %	3.821,18
222)		0000000069 R301388	PBX spojni modula za voice panel, 10xRJ45/u, (4-5, 7-8)	kom	20 %	4.333,06
223)		0000000070 R35122	PBX koncentratorski spojni modula za voice panel, ulaz 8xRJ45/u, izlaz 2xRJ45/u	kom	20 %	6.527,86

### Utičnice za RJ45 module

Global

Proizvođač: Reichle & De-Massari

		Web šifra	Kat.oznaka	Naziv proizvoda	Jed.mere	PDV	Cena (din)
224)		000000219	R310786	Nazidna utičnica 80x80 za 2xRJ45 modula, bela, Global	kom	20 %	668,11
225)		000000220	R507880	Nazidna utičnica 88x88 za 3xRJ45 modula, bela, Global	kom	20 %	988,03
226)		000000221	R310788	Uzidna utičnica 88x88 za 2xRJ45 modula, bela, Global	kom	20 %	488,06
227)		000000223	R507877	Uzidna utičnica 88x88 za 3xRJ45 modula, bela, Global	kom	20 %	891,31
228)		000000224	R305150	Uzidna utičnica 88x88 za 4xRJ45 modula, bela, Global	kom	20 %	906,19

229)		0000000225 R310790	Kanalska utičnica 80x86 za 2xRJ45 modula, bela, Global	kom	20 %	488,06
230)		0000000227 R507878	Kanalska utičnica 80x86 za 3xRJ45 modula, bela, Global	kom	20 %	891,31
231)		0000000228 R305151	Kanalska utičnica 80x86 za 4xRJ45 modula, bela, Global	kom	20 %	821,38
232)		0000000229 R318205	Kanalska utičnica 84x84 za 2xRJ45 modula, bela, Global	kom	20 %	1.049,04

#### Mini nazidne utičnice





Proizvođač: Reichle & De-Massari

	Web šifra	Kat.oznaka	Naziv proizvoda	Jed.mere	PDV	Cena (din)
233)		0000000230 R303903	Mini nazidna utičnica sa 1xRJ11/u modul, bela	kom	20 %	1.535,62

234)		0000000231 R303901	Mini nazidna utičnica za 1xRJ45 modul, bela	kom	20 %	699,36
------	---	--------------------	---	-----	------	--------

### Maska tipa mozaik (45x45 mm)

Proizvođač: Reichle & De-Massari

		Web šifra	Kat.oznaka	Naziv proizvoda	Jed.mere	PDV	Cena (din)
235)		0000000236	R313330	Maska tipa mozaik (45x45) za 2xRJ45 modula, ravna, bela, freenet	kom	20 %	419,62
236)		0000000237	R313333	Maska tipa mozaik (45x45) za 2xRJ45 modula, ravna, crna, freenet	kom	20 %	419,62
237)		0000000238	R506663	Maska tipa mozaik (45x45) za 1xRJ45 modul, kosa, bela, freenet	kom	20 %	398,78
238)		0000000239	R313332	Maska tipa mozaik (45x45) za 2xRJ45 modula, kosa, bela, freenet	kom	20 %	404,74

239)



000000240 R313331

Maska tipa mozaik (45x45) za 2xRJ45 modula, kosa, crna, freenet

kom

20 %

404,74

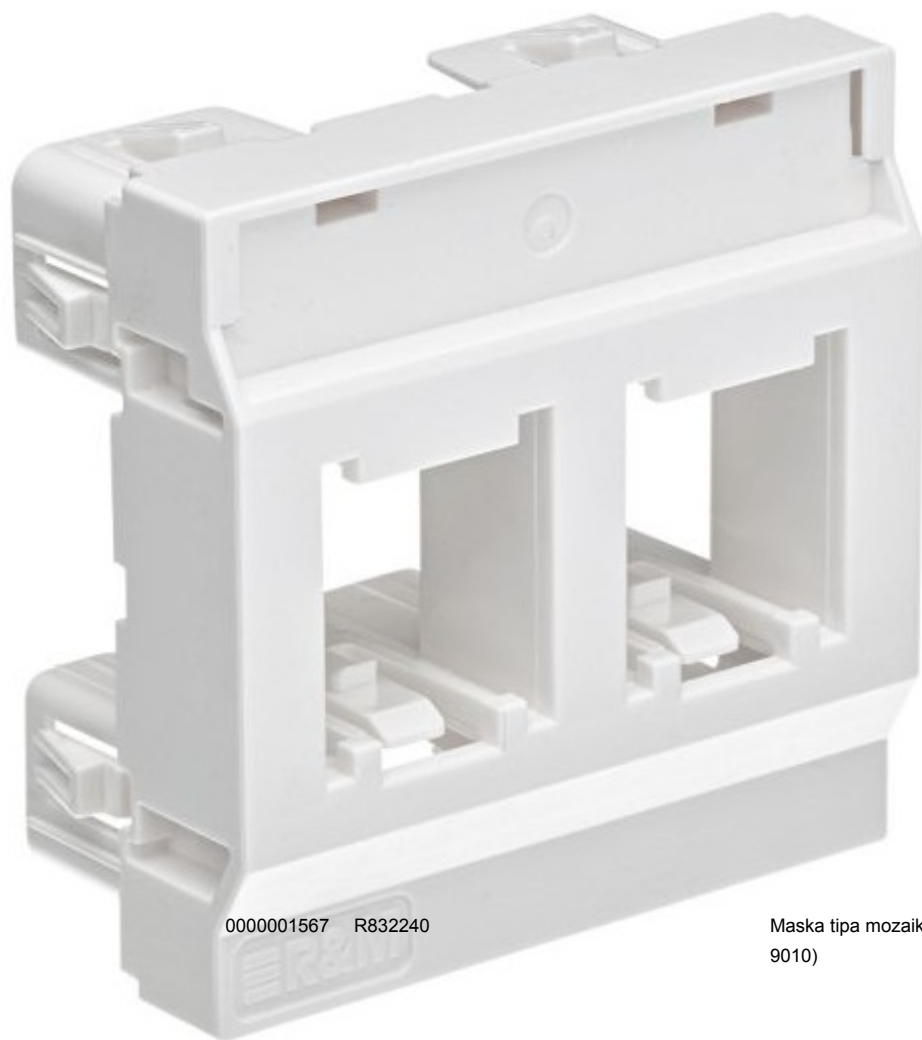

240)

0000001567 R832240

Maska tipa mozaik (45x45) za 2xRJ45 modula, ravna, bela (RAL 9010)

kom

20 %

404,74



241)

0000001568 R833450

Maska tipa mozaik (45x45) za 2xRJ45 modula, ravna, bela (RAL 9003)

kom

20 %

419,62



242)

0000001569 R833451

Maska tipa mozaik (45x45) za 2xRJ45 modula, ravna, crna (RAL 9005)

kom

20 %

419,62

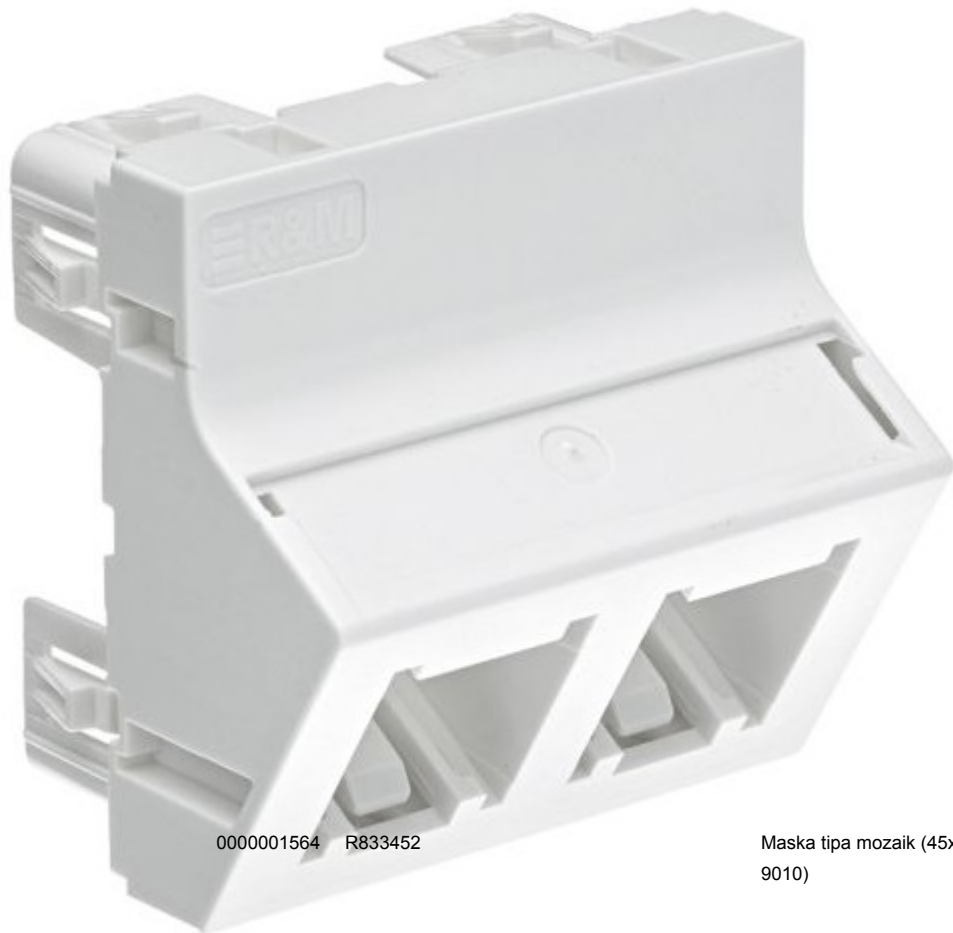

243)

000001564 R833452

Maska tipa mozaik (45x45) za 2xRJ45 modula, kosa, bela (RAL 9010)

kom

20 %

404,74

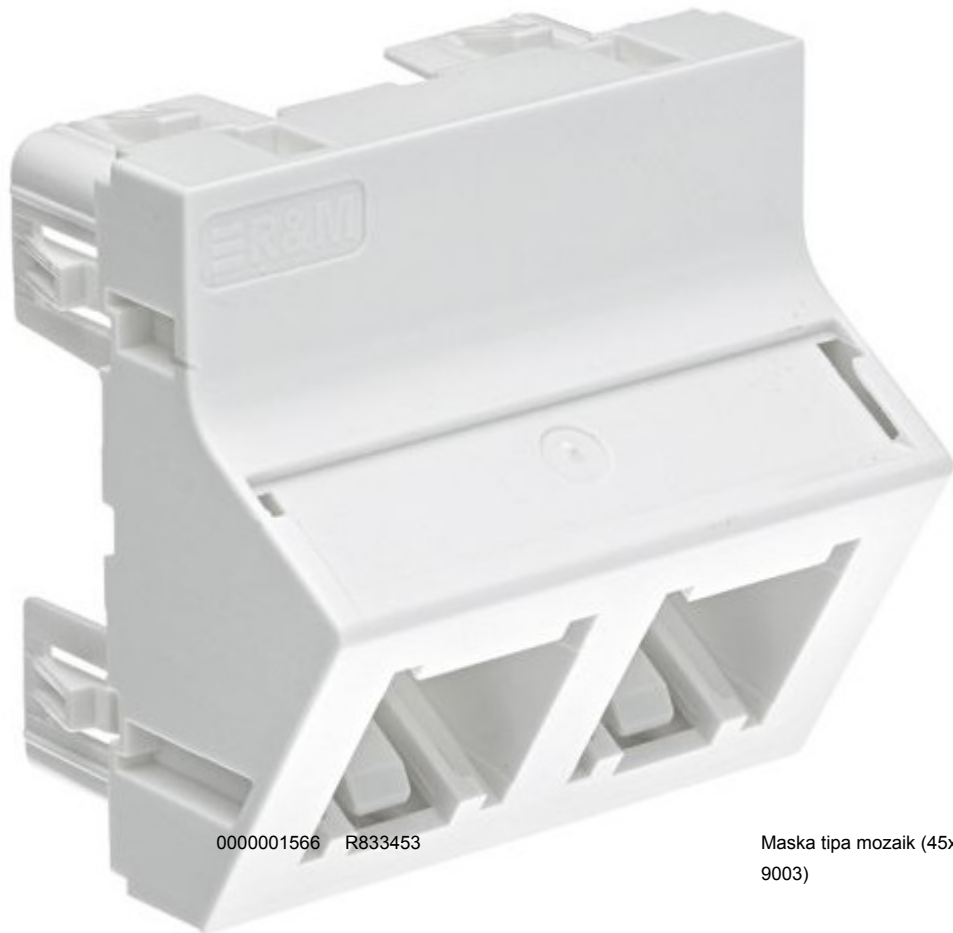

244)

000001566 R833453

Maska tipa mozaik (45x45) za 2xRJ45 modula, kosa, bela (RAL 9003)

kom

20 %

419,62



245)

000001565

Maska tipa mozaik (45x45) za 2xRJ45 modula, kosa, crna (RAL 9005)

kom

20 %

419,62

#### IP44 utičnice

Proizvođač: Reichle & De-Massari

Web šifra    Kat.oznaka

Naziv proizvoda

Jed.mere

PDV

Cena (din)

246)		0000001431	R503476	Nazidna utičnica 93x90 za 2xRJ45 modula, IP44, sa bravicom	kom	20 %	10.963,58
------	---	------------	---------	--	-----	------	-----------

#### Adapteri

Proizvođač: Reichle & De-Massari







	Web šifra	Kat.oznaka	Naziv proizvoda	Jed.mere	PDV	Cena (din)	
247)		0000001282	R314000	Držač modula za DIN šinu, plastični, DRM45	kom	20 %	2.098,08







#### Prespojni kablovi - bakarni







##### Prespojni kablovi Cat.5e



Proizvođač: Reichle & De-Massari



	Web šifra	Kat.oznaka	Naziv proizvoda	Jed.mere	PDV	Cena (din)	
248)		0000000121	R802907	Prespojni kabl Cat.5e, U/UTP, 4P, LSZH, RJ-45/u-RJ45/u, 1.0 m	kom	20 %	310,99

249)		0000000122	R802906	Prespojni kabl Cat.5e, U/UTP, 4P, LSZH, RJ-45/u-RJ45/u, 1.5 m	kom	20 %	386,88
250)		0000000123	R802310	Prespojni kabl Cat.5e, U/UTP, 4P, LSZH, RJ-45/u-RJ45/u, 2.0 m	kom	20 %	440,45
251)		0000000124	R802296	Prespojni kabl Cat.5e, U/UTP, 4P, LSZH, RJ-45/u-RJ45/u, 3.0 m	kom	20 %	504,43
252)		0000000125	R802309	Prespojni kabl Cat.5e, U/UTP, 4P, LSZH, RJ-45/u-RJ45/u, 5.0 m	kom	20 %	598,18
253)		0000000094	R305014	Prespojni kabl Cat.5e, U/UTP, 4P, PVC, RJ-45/u-RJ45/u, 0.5 m	kom	20 %	785,66
254)		0000000095	R305015	Prespojni kabl Cat.5e, U/UTP, 4P, PVC, RJ-45/u-RJ45/u, 1.0 m	kom	20 %	857,09

255)		0000000096	R305019	Prespojni kabl Cat.5e, U/UTP, 4P, PVC, RJ-45/u-RJ45/u, 1.5 m	kom	20 %	928,51
256)		0000000097	R305020	Prespojni kabl Cat.5e, U/UTP, 4P, PVC, RJ-45/u-RJ45/u, 2.0 m	kom	20 %	999,94
257)		0000000098	R305021	Prespojni kabl Cat.5e, U/UTP, 4P, PVC, RJ-45/u-RJ45/u, 3.0 m	kom	20 %	1.142,78
258)		0000000099	R305022	Prespojni kabl Cat.5e, U/UTP, 4P, PVC, RJ-45/u-RJ45/u, 5.0 m	kom	20 %	1.425,50
259)		0000000116	R802308	Prespojni kabl Cat.5e, S/UTP, 4P, LS0H, RJ-45/s-RJ45/s, 1.0 m	kom	20 %	621,98
260)		0000000117	R802303	Prespojni kabl Cat.5e, S/UTP, 4P, LS0H, RJ-45/s-RJ45/s, 1.5 m	kom	20 %	613,06



261)		0000000118	R802307	Prespojni kabl Cat.5e, S/UTP, 4P, LS0H, RJ-45/s-RJ45/s, 2.0 m	kom	20 %	651,74
262)		0000000119	R802305	Prespojni kabl Cat.5e, S/UTP, 4P, LS0H, RJ-45/s-RJ45/s, 3.0 m	kom	20 %	806,50
263)		0000000120	R802306	Prespojni kabl Cat.5e, S/UTP, 4P, LS0H, RJ-45/s-RJ45/s, 5.0 m	kom	20 %	916,61
264)		0000000105	R305039	Prespojni kabl Cat.5e, SF/UTP, 4P, LSFZRZH, RJ-45/s-RJ45/s, 0.5 m	kom	20 %	999,94
265)		0000000106	R305040	Prespojni kabl Cat.5e, SF/UTP, 4P, LSFZRZH, RJ-45/s-RJ45/s, 1.0 m	kom	20 %	1.077,31
266)		0000000107	R305041	Prespojni kabl Cat.5e, SF/UTP, 4P, LSFZRZH, RJ-45/s-RJ45/s, 1.5 m	kom	20 %	1.154,69





267)		0000000108	R305042	Prespojni kabl Cat.5e, SF/UTP, 4P, LSFRZH, RJ-45/s-RJ45/s, 2.0 m	kom	20 %	1.235,04
268)		0000000109	R305043	Prespojni kabl Cat.5e, SF/UTP, 4P, LSFRZH, RJ-45/s-RJ45/s, 3.0 m	kom	20 %	1.389,79
269)		0000000110	R305044	Prespojni kabl Cat.5e, SF/UTP, 4P, LSFRZH, RJ-45/s-RJ45/s, 5.0 m	kom	20 %	1.705,25
270)		0000000127	R305061	Prespojni kabl Cat.5e, SF/UTP, 4P, LSFRZH, RJ-45/s-RJ45/u, 0.5 m	kom	20 %	895,78
271)		0000000128	R305062	Prespojni kabl Cat.5e, SF/UTP, 4P, LSFRZH, RJ-45/s-RJ45/u, 1.0 m	kom	20 %	976,13
272)		0000000129	R305063	Prespojni kabl Cat.5e, SF/UTP, 4P, LSFRZH, RJ-45/s-RJ45/u, 1.5 m	kom	20 %	1.053,50

273)		0000000130	R305064	Prespojni kabl Cat.5e, SF/UTP, 4P, LSFRZH, RJ-45/s-RJ45/u, 2.0 m	kom	20 %	1.130,88
274)		0000000131	R305065	Prespojni kabl Cat.5e, SF/UTP, 4P, LSFRZH, RJ-45/s-RJ45/u, 3.0 m	kom	20 %	1.288,61
275)		0000000132	R305066	Prespojni kabl Cat.5e, SF/UTP, 4P, LSFRZH, RJ-45/s-RJ45/u, 5.0 m	kom	20 %	1.604,06

#### Prespojni kablovi Cat.6

Proizvođač: Reichle & De-Massari





		Web šifra	Kat.oznaka	Naziv proizvoda	Jed.mere	PDV	Cena (din)
276)		0000000137	R302309	Prespojni kabl Cat.6, U/UTP, 4P, LSZH, RJ-45/u-RJ45/u, 0.5 m	kom	20 %	1.002,91
277)		0000000138	R302310	Prespojni kabl Cat.6, U/UTP, 4P, LSZH, RJ-45/u-RJ45/u, 1.0 m	kom	20 %	1.083,26

278)		0000000139 R302311	Prespojni kabl Cat.6, U/UTP, 4P, LSZH, RJ-45/u-RJ45/u, 1.5 m	kom	20 %	1.163,62
279)		0000000140 R302312	Prespojni kabl Cat.6, U/UTP, 4P, LSZH, RJ-45/u-RJ45/u, 2.0 m	kom	20 %	1.246,94
280)		0000000141 R302313	Prespojni kabl Cat.6, U/UTP, 4P, LSZH, RJ-45/u-RJ45/u, 3.0 m	kom	20 %	1.407,65
281)		0000000142 R302314	Prespojni kabl Cat.6, U/UTP, 4P, LSZH, RJ-45/u-RJ45/u, 5.0 m	kom	20 %	1.735,01

**Prespojni kablovi EL Cat.6**

**Proizvođač: Reichle & De-Massari**



	<b>Web šifra</b>	<b>Kat.oznaka</b>	<b>Naziv proizvoda</b>	<b>Jed.mere</b>	<b>PDV</b>	<b>Cena (din)</b>
282)		0000001481 R830719	Prespojni kabl EL Cat.6, U/UTP, 4P, PVC, RJ-45/u-RJ45/u, 1.0 m	kom	20 %	868,99







283)		0000001482	R830822	Prespojni kabl EL Cat.6, U/UTP, 4P, PVC, RJ-45/u-RJ45/u, 1.5 m	kom	20 %	906,19
284)		0000001483	R830720	Prespojni kabl EL Cat.6, U/UTP, 4P, PVC, RJ-45/u-RJ45/u, 2.0 m	kom	20 %	938,93
285)		0000001484	R830721	Prespojni kabl EL Cat.6, U/UTP, 4P, PVC, RJ-45/u-RJ45/u, 3.0 m	kom	20 %	1.010,35
286)		0000001485	R830722	Prespojni kabl EL Cat.6, U/UTP, 4P, PVC, RJ-45/u-RJ45/u, 5.0 m	kom	20 %	1.150,22
287)		0000001486	R820301	Prespojni kabl EL Cat.6, U/FTP, 4P, LSZH, RJ-45/s-RJ45/s, 1.0 m	kom	20 %	1.163,62
288)		0000001487	R820305	Prespojni kabl EL Cat.6, U/FTP, 4P, LSZH, RJ-45/s-RJ45/s, 1.5 m	kom	20 %	1.163,62



289)		0000001488	R820302	Prespojni kabl EL Cat.6, U/FTP, 4P, LSZH, RJ-45/s-RJ45/s, 2.0 m	kom	20 %	1.282,66
290)		0000001489	R820303	Prespojni kabl EL Cat.6, U/FTP, 4P, LSZH, RJ-45/s-RJ45/s, 3.0 m	kom	20 %	1.400,21
291)		0000001490	R820304	Prespojni kabl EL Cat.6, U/FTP, 4P, LSZH, RJ-45/s-RJ45/s, 5.0 m	kom	20 %	1.639,78

#### Prespojni kablovi Cat.6A

Proizvođač: Reichle & De-Massari

	Web šifra	Kat.oznaka	Naziv proizvoda	Jed.mere	PDV	Cena (din)	
292)		0000000164	R509869	Prespojni kabl Cat.6A ISO, U/UTP, 4P, LSFRZH, RJ-45/u-RJ45/u, 0.5 m	kom	20 %	1.136,83
293)		0000000165	R509870	Prespojni kabl Cat.6A ISO, U/UTP, 4P, LSFRZH, RJ-45/u-RJ45/u, 1.0 m	kom	20 %	1.217,18

294)		0000000166	R509871	Prespojni kabl Cat.6A ISO, U/UTP, 4P, LSFRZH, RJ-45/u-RJ45/u, 1.5 m	kom	20 %	1.300,51
295)		0000000167	R509872	Prespojni kabl Cat.6A ISO, U/UTP, 4P, LSFRZH, RJ-45/u-RJ45/u, 2.0 m	kom	20 %	1.380,86
296)		0000000168	R509873	Prespojni kabl Cat.6A ISO, U/UTP, 4P, LSFRZH, RJ-45/u-RJ45/u, 3.0 m	kom	20 %	1.544,54
297)		0000000169	R509874	Prespojni kabl Cat.6A ISO, U/UTP, 4P, LSFRZH, RJ-45/u-RJ45/u, 5.0 m	kom	20 %	1.868,93
298)		0000000175	R509857	Prespojni kabl Cat.6A ISO, S/FTP, 4P, LSFRZH, RJ-45/s-RJ45/s, 0.5 m	kom	20 %	1.526,69
299)		0000000176	R509858	Prespojni kabl Cat.6A ISO, S/FTP, 4P, LSFRZH, RJ-45/s-RJ45/s, 1.0 m	kom	20 %	1.630,85



300)		0000000177	R509860	Prespojni kabl Cat.6A ISO, S/FTP, 4P, LSFRZH, RJ-45/s-RJ45/s, 1.5 m	kom	20 %	1.737,98
301)		0000000178	R509861	Prespojni kabl Cat.6A ISO, S/FTP, 4P, LSFRZH, RJ-45/s-RJ45/s, 2.0 m	kom	20 %	1.842,14
302)		0000000179	R509862	Prespojni kabl Cat.6A ISO, S/FTP, 4P, LSFRZH, RJ-45/s-RJ45/s, 3.0 m	kom	20 %	2.050,46
303)		0000000180	R509863	Prespojni kabl Cat.6A ISO, S/FTP, 4P, LSFRZH, RJ-45/s-RJ45/s, 5.0 m	kom	20 %	2.470,08

**Prespojni kablovi EL Cat.6A**

**Proizvođač: Reichle & De-Massari**



	<b>Web šifra</b>	<b>Kat.oznaka</b>	<b>Naziv proizvoda</b>	<b>Jed.mere</b>	<b>PDV</b>	<b>Cena (din)</b>	
304)		0000001471	R830779	Prespojni kabl EL Cat.6A, U/UTP, 4P, LSZH, RJ-45/u-RJ45/u, 1.0 m	kom	20 %	922,56

305)		0000001472	R830824	Prespojni kabl EL Cat.6A, U/UTP, 4P, LSZH, RJ-45/u-RJ45/u, 1.5 m	kom	20 %	982,08
306)		0000001473	R830780	Prespojni kabl EL Cat.6A, U/UTP, 4P, LSZH, RJ-45/u-RJ45/u, 2.0 m	kom	20 %	1.041,60
307)		0000001474	R830781	Prespojni kabl EL Cat.6A, U/UTP, 4P, LSZH, RJ-45/u-RJ45/u, 3.0 m	kom	20 %	1.160,64
308)		0000001475	R830783	Prespojni kabl EL Cat.6A, U/UTP, 4P, LSZH, RJ-45/u-RJ45/u, 5.0 m	kom	20 %	1.397,23
309)		0000001476	R830749	Prespojni kabl EL Cat.6A, U/FTP, 4P, LSZH, RJ-45/s-RJ45/s, 1.0 m	kom	20 %	1.272,24
310)		0000001477	R830823	Prespojni kabl EL Cat.6A, U/FTP, 4P, LSZH, RJ-45/s-RJ45/s, 1.5 m	kom	20 %	1.331,76





311)		0000001478	R830750	Prespojni kabl EL Cat.6A, U/FTP, 4P, LSZH, RJ-45/s-RJ45/s, 2.0 m	kom	20 %	1.391,28
312)		0000001479	R830751	Prespojni kabl EL Cat.6A, U/FTP, 4P, LSZH, RJ-45/s-RJ45/s, 3.0 m	kom	20 %	1.510,32
313)		0000001480	R830752	Prespojni kabl EL Cat.6A, U/FTP, 4P, LSZH, RJ-45/s-RJ45/s, 5.0 m	kom	20 %	1.748,40

**Prespojni kablovi Cat.6 i Cat.6A Basic Line Thin**

**Proizvođač: Reichle & De-Massari**

		<b>Web šifra</b>	<b>Kat.oznaka</b>	<b>Naziv proizvoda</b>	<b>Jed.mere</b>	<b>PDV</b>	<b>Cena (din)</b>
314)		0000001527	R833690	Basic Line Thin prespojni kabl Cat.6, U/UTP, 4P, LSZH, RJ-45/u-RJ45/u, 1.0 m	kom	20 %	325,87
315)		0000001528	R836994	Basic Line Thin prespojni kabl Cat.6, U/UTP, 4P, LSZH, RJ-45/u-RJ45/u, 2.0 m	kom	20 %	351,17

316)		0000001529	R836995	Basic Line Thin prespojni kabl Cat.6, U/UTP, 4P, LSZH, RJ-45/u-RJ45/u, 3.0 m	kom	20 %	520,80
317)		0000001530	R836996	Basic Line Thin prespojni kabl Cat.6, U/UTP, 4P, LSZH, RJ-45/u-RJ45/u, 5.0 m	kom	20 %	696,38
318)		0000001501	R836997	Basic Line Thin prespojni kabl Cat.6A, U/UTP, 4P, LSZH, RJ-45/u-RJ45/u, 1.0 m	kom	20 %	455,33
319)		0000001502	R836998	Basic Line Thin prespojni kabl Cat.6A, U/UTP, 4P, LSZH, RJ-45/u-RJ45/u, 2.0 m	kom	20 %	549,07
320)		0000001503	R836999	Basic Line Thin prespojni kabl Cat.6A, U/UTP, 4P, LSZH, RJ-45/u-RJ45/u, 3.0 m	kom	20 %	633,89
321)		0000001504	R837001	Basic Line Thin prespojni kabl Cat.6A, U/UTP, 4P, LSZH, RJ-45/u-RJ45/u, 5.0 m	kom	20 %	824,35





322)		0000001505	R837002	Basic Line Thin prespojni kabl Cat.6A, U/FTP, 4P, LSZH, RJ-45/s-RJ45/s, 1.0 m	kom	20 %	473,18
323)		0000001506	R837003	Basic Line Thin prespojni kabl Cat.6A, U/FTP, 4P, LSZH, RJ-45/s-RJ45/s, 2.0 m	kom	20 %	543,12
324)		0000001507	R83705	Basic Line Thin prespojni kabl Cat.6A, U/FTP, 4P, LSZH, RJ-45/s-RJ45/s, 3.0 m	kom	20 %	589,25
325)		0000001508	R837006	Basic Line Thin prespojni kabl Cat.6A, U/FTP, 4P, LSZH, RJ-45/s-RJ45/s, 5.0 m	kom	20 %	922,56



**Prespojni kablovi Cat.6 i Cat.6A Thin Line**

**Proizvođač: Reichle & De-Massari**

	Web šifra	Kat.oznaka	Naziv proizvoda	Jed.mere	PDV	Cena (din)	
326)		0000001536	R860820	Thin Line prespojni kabl Cat.6, U/UTP, 4P, LSZH, RJ-45/u-RJ45/u, 0.5 m	kom	20 %	982,08



327)		0000001532	R860822	Thin Line prespojni kabl Cat.6, U/UTP, 4P, LSZH, RJ-45/u-RJ45/u, 1.0 m	kom	20 %	1.047,55
328)		0000001533	R860823	Thin Line prespojni kabl Cat.6, U/UTP, 4P, LSZH, RJ-45/u-RJ45/u, 2.0 m	kom	20 %	1.169,57
329)		0000001534	R860824	Thin Line prespojni kabl Cat.6, U/UTP, 4P, LSZH, RJ-45/u-RJ45/u, 3.0 m	kom	20 %	1.294,56
330)		0000001535	R860825	Thin Line prespojni kabl Cat.6, U/UTP, 4P, LSZH, RJ-45/u-RJ45/u, 5.0 m	kom	20 %	1.544,54
331)		0000001491	R861030	Thin Line prespojni kabl Cat.6A, U/UTP, 4P, LSZH, RJ-45/u-RJ45/u, 0.5 m	kom	20 %	1.127,90
332)		0000001492	R861031	Thin Line prespojni kabl Cat.6A, U/UTP, 4P, LSZH, RJ-45/u-RJ45/u, 1.0 m	kom	20 %	1.199,33



333)		0000001493	R861032	Thin Line prespojni kabl Cat.6A, U/UTP, 4P, LSZH, RJ-45/u-RJ45/u, 2.0 m	kom	20 %	1.339,20
334)		0000001494	R861033	Thin Line prespojni kabl Cat.6A, U/UTP, 4P, LSZH, RJ-45/u-RJ45/u, 3.0 m	kom	20 %	1.482,05
335)		0000001495	R861034	Thin Line prespojni kabl Cat.6A, U/UTP, 4P, LSZH, RJ-45/u-RJ45/u, 5.0 m	kom	20 %	1.764,77
336)		0000001496	R861040	Thin Line prespojni kabl Cat.6A, U/FTP, 4P, LSZH, RJ-45/s-RJ45/s, 0.5 m	kom	20 %	1.490,98
337)		0000001497	R861041	Thin Line prespojni kabl Cat.6A, U/FTP, 4P, LSZH, RJ-45/s-RJ45/s, 1.0 m	kom	20 %	1.562,40
338)		0000001498	R861042	Thin Line prespojni kabl Cat.6A, U/FTP, 4P, LSZH, RJ-45/s-RJ45/s, 2.0 m	kom	20 %	1.702,27

339)		0000001499	R861043	Thin Line prespojni kabl Cat.6A, U/FTP, 4P, LSZH, RJ-45/s-RJ45/s, 3.0 m	kom	20 %	1.842,14
340)		0000001500	R861044	Thin Line prespojni kabl Cat.6A, U/FTP, 4P, LSZH, RJ-45/s-RJ45/s, 5.0 m	kom	20 %	2.121,89

### Prespojni kablovi Cat.6 i Cat.6A Health Line



**Proizvođač: Reichle & De-Massari**

		Web šifra	Kat.oznaka	Naziv proizvoda	Jed.mere	PDV	Cena (din)
341)		0000001509	R825749	Health Line prespojni kabl Cat.6, U/UTP, 4P, LSZH, RJ-45/u-RJ45/u, 2.0 m	kom	20 %	1.434,43
342)		0000001510	R825750	Health Line prespojni kabl Cat.6, U/UTP, 4P, LSZH, RJ-45/u-RJ45/u, 3.0 m	kom	20 %	1.601,09
343)		0000001511	R825751	Health Line prespojni kabl Cat.6, U/UTP, 4P, LSZH, RJ-45/u-RJ45/u, 5.0 m	kom	20 %	1.990,94



344)		0000001512 R825752	Health Line prespojni kabl Cat.6A, S/FTP, 4P, LSFRZH, RJ-45/s-RJ45/s, 2.0 m	kom	20 %	1.982,02
345)		0000001513 R825753	Health Line prespojni kabl Cat.6A, S/FTP, 4P, LSFRZH, RJ-45/s-RJ45/s, 3.0 m	kom	20 %	2.243,90
346)		0000001514 R825754	Health Line prespojni kabl Cat.6A, S/FTP, 4P, LSFRZH, RJ-45/s-RJ45/s, 5.0 m	kom	20 %	2.731,97

#### Prespojni kablovi Cat.6A industrijski

Proizvođač: Reichle & De-Massari



		Web šifra	Kat.oznaka	Naziv proizvoda	Jed.mere	PDV	Cena (din)
347)		0000001516	R313633	Prespojni kabl Cat.6A, S/FTP, 4P, PUR, zelen, RJ-45/s IP20 - RJ45/s IP20, 2.5 m	kom	20 %	3.565,25
348)		0000001517	R313634	Prespojni kabl Cat.6A, S/FTP, 4P, PUR, zelen, RJ-45/s IP20 - RJ45/s IP20, 5.0 m	kom	20 %	5.350,85

349)		0000001518	R313632	Prespojni kabl Cat.6A, S/FTP, 4P, PUR, zelen, RJ-45/s IP20 - RJ45/s IP20, 10.0 m	kom	20 %	9.276,19
350)		0000001519	R313637	Prespojni kabl Cat.6A, S/FTP, 4P, PUR, zelen, RJ-45/s IP67 tip 06 - RJ45/s IP20, 2.5 m	kom	20 %	5.505,60
351)		0000001520	R313638	Prespojni kabl Cat.6A, S/FTP, 4P, PUR, zelen, RJ-45/s IP67 tip 06 - RJ45/s IP20, 5.0 m	kom	20 %	7.195,97
352)		0000001521	R313639	Prespojni kabl Cat.6A, S/FTP, 4P, PUR, zelen, RJ-45/s IP67 tip 06 - RJ45/s IP20, 7.5 m	kom	20 %	9.160,13
353)		0000001522	R313636	Prespojni kabl Cat.6A, S/FTP, 4P, PUR, zelen, RJ-45/s IP67 tip 06 - RJ45/s IP20, 10.0 m	kom	20 %	11.121,31
354)		0000001523	R313641	Prespojni kabl Cat.6A, S/FTP, 4P, PUR, zelen, RJ-45/s IP67 tip 06 - RJ45/s IP67 tip 06, 2.5 m	kom	20 %	7.448,93

355)		0000001524	R313642	Prespojni kabl Cat.6A, S/FTP, 4P, PUR, zelen, RJ-45/s IP67 tip 06 - RJ45/s IP67 tip 06, 5.0 m	kom	20 %	9.041,09
356)		0000001525	R313643	Prespojni kabl Cat.6A, S/FTP, 4P, PUR, zelen, RJ-45/s IP67 tip 06 - RJ45/s IP67 tip 06, 7.5 m	kom	20 %	11.005,25
357)		0000001526	R313640	Prespojni kabl Cat.6A, S/FTP, 4P, PUR, zelen, RJ-45/s IP67 tip 06 - RJ45/s IP67 tip 06, 10.0 m	kom	20 %	12.966,43

### Telefonski prespojni kablovi





Proizvođač: Reichle & De-Massari

	Web šifra	Kat.oznaka	Naziv proizvoda	Jed.mere	PDV	Cena (din)	
358)		0000001105	R925693	Prespojni adapter kabl, U/UTP, 2P, PVC, RJ-45/u-RJ11/u, 3 m	kom	20 %	873,46
359)		0000001106	R925692	Prespojni adapter kabl, U/UTP, 2P, PVC, RJ-45/u-RJ11/u, 5 m	kom	20 %	1.041,60

## Telefonske reglete i oprema

### VS Standard - telefonske reglete

Proizvođač: Reichle & De-Massari



	Web šifra	Kat.oznaka	Naziv proizvoda	Jed.mere	PDV	Cena (din)
360)		0000001107 R27001-16-1	Telefonska regleta 8 parica, 2x0,65mm, sastavna	kom	20 %	1.068,38
361)		0000001108 R27001-20-1	Telefonska regleta 10 parica, 2x0,65mm, sastavna	kom	20 %	1.776,67
362)		0000001109 R27013-20-1	Telefonska regleta 10 parica, 1x0,80mm, sastavna	kom	20 %	1.952,26
363)		0000001248 R27002-16-1	Telefonska regleta 8 parica, 2x0,65mm, rastavna	kom	20 %	1.913,57

364)		0000001249 R27002-20-1	Telefonska regleta 10 parica , 2x0,65mm, rastavna	kom	20 %	1.982,02
------	---	------------------------	---	-----	------	----------

365)		0000001250 R27021-20-1	Telefonska regleta 10 parica , 1x0,80mm, rastavna	kom	20 %	2.845,06
------	---	------------------------	---	-----	------	----------

**VS Standard - držači regleta 19 inc**





**Proizvođač: Reichle & De-Massari**







	Web šifra	Kat.oznaka	Naziv proizvoda	Jed.mere	PDV	Cena (din)
366)		0000001110 R300234	19 inc, 1U držač regleta za 3 x 10 pari	kom	20 %	7.355,18
367)		0000001111 R27073	19 inc, 3U držač regleta za 16 x 10 pari	kom	20 %	36.519,98
368)		0000001112 R27074	19 inc, 3U držač regleta za 15 x 8 pari	kom	20 %	15.652,27



369)		0000001113 R27075	19 inc, 4U držač regleta za 16 x 10 pari	kom	20 %	14.247,60
------	---	-------------------	--	-----	------	-----------

**VS Modular - telefonske reglete**

**Proizvođač: Reichle & De-Massari**



	Web šifra	Kat.oznaka	Naziv proizvoda	Jed.mere	PDV	Cena (din)
370)		0000001242 R21001-05-04	Telefonska regleta VS83, 10 parica (5x4), sastavna	kom	20 %	2.723,04
371)		0000001240 R21001-10-02	Telefonska regleta VS83, 10 parica (10x2), sastavna	kom	20 %	2.723,04
372)		0000001243 R21080-05-04	Telefonska regleta VS88, 10 parica (5x4), sastavna	kom	20 %	2.609,95
373)		0000001244 R21080-10-02	Telefonska regleta VS88, 10 parica (10x2), sastavna	kom	20 %	2.627,81

374)		0000001245	R21080-08-03	Telefonska regleta VS88, 12 parica (8x3), sastavna	kom	20 %	3.267,65
375)		0000001246	R21080-06-04	Telefonska regleta VS88, 12 parica (6x4), sastavna	kom	20 %	3.267,65
376)		0000001387	R21002-20	Telefonska regleta VS83, 10 parica, rastavna	kom	20 %	2.925,41
377)		0000001388	R21081-20	Telefonska regleta VS88, 10 parica, rastavna	kom	20 %	2.836,13
378)		0000001389	R21081-24	Telefonska regleta VS88, 12 parica, rastavna	kom	20 %	3.511,68
379)		0000001241	R21003-20	Rastavni element za regletu VS83, 10 parica	kom	20 %	1.800,48

380)		0000001247 R21003-24	Rastavni element za regletu VS83, 12 parica	kom	20 %	2.163,55
381)		0000001398 R20032-1	Oprema za obeležavanje VS modular regleta	kom	20 %	675,55

### VS Modular - zaštitni elementi

**Proizvođač: Reichle & De-Massari**







	Web šifra	Kat.oznaka	Naziv proizvoda	Jed.mere	PDV	Cena (din)
382)		0000001390 R21040-20	Prenaponska zaštita sa 2 elektrode, 230V, 10 parica	kom	20 %	12.558,72
383)		0000001391 R21040-24	Prenaponska zaštita sa 2 elektrode, 230V, 12 parica	kom	20 %	16.013,86
384)		0000001392 R27471-110	Strujna zaštita sa varistorom, 1 parica, 110V/145mA	kom	20 %	5.440,13







385)		0000001393 R27471-180	Strujna zaštita sa varistorom, 1 parica, 180V/145mA	kom	20 %	5.440,13
386)		0000001395 R27451-120PTC	Strujna zaštita sa PTC, 1 parica, 120mA	kom	20 %	1.322,83
387)		0000001396 R27451-145PTC	Strujna zaštita sa PTC, 1 parica, 145mA	kom	20 %	1.322,83
388)		0000001397 R27451-180PTC	Strujna zaštita sa PTC, 1 parica, 180mA	kom	20 %	1.440,38

#### VS Modular - vertikalni metalni nosači V/V

Proizvođač: Reichle & De-Massari

	Web šifra	Kat.oznaka	Naziv proizvoda	Jed.mere	PDV	Cena (din)
389)		0000001327 R20176-030-12	Vertikalni metalni nosač, tip A, 030 x 360 mm / 12	kom	20 %	6.752,54



390)		0000001328 R20176-060-16	Vertikalni metalni nosač, tip A, 060 x 480 mm / 16	kom	20 %	9.127,39
391)		0000001329 R20176-060-26	Vertikalni metalni nosač, tip A, 060 x 780 mm / 26	kom	20 %	12.594,43
392)		0000001330 R20176-150-36	Vertikalni metalni nosač, tip A, 150 x 1080 mm / 36	kom	20 %	21.171,26
393)		0000001331 R20176-150-46	Vertikalni metalni nosač, tip A, 150 x 1380 mm / 46	kom	20 %	24.095,18
394)		0000001332 R20176-150-56	Vertikalni metalni nosač, tip A, 150 x 1680 mm / 56	kom	20 %	27.013,15
395)		0000001333 R20176-150-66	Vertikalni metalni nosač, tip A, 150 x 1980 mm / 66	kom	20 %	31.392,34

396)		0000001334 R20176-150-76	Vertikalni metalni nosač, tip A, 150 x 2280 mm / 76	kom	20 %	36.868,18
397)		0000001335 R20176-150-86	Vertikalni metalni nosač, tip A, 150 x 2580 mm / 86	kom	20 %	41.616,38
398)		0000001336 R20176-210-66	Vertikalni metalni nosač, tip A, 210 x 1980 mm / 66	kom	20 %	44.535,84
399)		0000001337 R20176-210-76	Vertikalni metalni nosač, tip A, 210 x 2280 mm / 76	kom	20 %	47.452,32
400)		0000001338 R20177-150-86	Vertikalni metalni nosač, tip B, 150 x 2580 mm / 86	kom	20 %	45.078,96
401)		0000001339 R20177-210-56	Vertikalni metalni nosač, tip B, 210 x 1680 mm / 56	kom	20 %	41.616,38

402)		0000001340 R20177-210-66	Vertikalni metalni nosač, tip B, 210 x 1980 mm / 66	kom	20 %	44.535,84
403)		0000001341 R20177-210-76	Vertikalni metalni nosač, tip B, 210 x 2280 mm / 76	kom	20 %	47.452,32
404)		0000001342 R20177-210-86	Vertikalni metalni nosač, tip B, 210 x 2580 mm / 86	kom	20 %	50.005,73

**VS Modular - držač modula 19 inc**



**Proizvođač: Reichle & De-Massari**







		<b>Web šifra</b>	<b>Kat.oznaka</b>	<b>Naziv proizvoda</b>	<b>Jed.mere</b>	<b>PDV</b>	<b>Cena (din)</b>
405)		0000001343	R24122-3	19 inc, 3U držač regleta, VS modular tip S	kom	20 %	38.240,11
406)		0000001344	R24122-4	19 inc, 4U držač regleta, VS modular tip S	kom	20 %	44.329,01





**Alat i merna oprema****Proizvođač: Reichle & De-Massari**

	<b>Web šifra</b>	<b>Kat.oznaka</b>	<b>Naziv proizvoda</b>	<b>Jed.mere</b>	<b>PDV</b>	<b>Cena (din)</b>
407)	 0000001468	R19001	Alat za utiskivanje žice u regletu	kom	20 %	7.820,93



**Instalacioni kablovi - optički****Breakout I-V(ZN)HH****Proizvođač: Reichle & De-Massari**



	<b>Web šifra</b>	<b>Kat.oznaka</b>	<b>Naziv proizvoda</b>	<b>Jed.mere</b>	<b>PDV</b>	<b>Cena (din)</b>
408)	 0000000356	R314479	SM Breakout kabl, I-V(ZN)HH, G.652.D, 2 vlakna, OS2	m	20 %	468,72
409)	 0000000357	R314480	SM Breakout kabl, I-V(ZN)HH, G.652.D, 4 vlakna, OS2	m	20 %	565,44

410)		0000000358 R314481	SM Breakout kabl, I-V(ZN)HH, G.652.D, 6 vlakana, OS2	m	20 %	757,39
411)		0000000359 R314248	SM Breakout kabl, I-V(ZN)HH, G.652.D, 8 vlakana, OS2	m	20 %	1.081,78
412)		0000000360 R314249	SM Breakout kabl, I-V(ZN)HH, G.652.D, 12 vlakana, OS2	m	20 %	1.357,06
413)		0000000361 R314484	SM Breakout kabl, I-V(ZN)HH, G.652.D, 16 vlakana, OS2	m	20 %	1.464,19
414)		0000000362 R314250	SM Breakout kabl, I-V(ZN)HH, G.652.D, 24 vlakana, OS2	m	20 %	2.352,53
415)		0000000363 R314458	MM Breakout kabl, I-V(ZN)HH, OM1, 2 vlakna	m	20 %	477,65

416)		0000000364	R314459	MM Breakout kabl, I-V(ZN)HH, OM1, 4 vlakna	m	20 %	592,22
417)		0000000365	R314460	MM Breakout kabl, I-V(ZN)HH, OM1, 6 vlakana	m	20 %	787,15
418)		0000000366	R314239	MM Breakout kabl, I-V(ZN)HH, OM1, 8 vlakana	m	20 %	1.047,55
419)		0000000367	R314463	MM Breakout kabl, I-V(ZN)HH, OM1, 16 vlakana	m	20 %	1.590,67
420)		0000000368	R314245	MM Breakout kabl, I-V(ZN)HH, OM1, 24 vlakana	m	20 %	2.568,29
421)		0000000369	R314465	MM Breakout kabl, I-V(ZN)HH, OM2, 2 vlakna	m	20 %	496,99

422)		0000000370	R314466	MM Breakout kabl, I-V(ZN)HH, OM2, 4 vlakna	m	20 %	623,47
423)		0000000371	R314467	MM Breakout kabl, I-V(ZN)HH, OM2, 6 vlakana	m	20 %	833,28
424)		0000000372	R314240	MM Breakout kabl, I-V(ZN)HH, OM2, 8 vlakana	m	20 %	1.159,15
425)		0000000373	R314243	MM Breakout kabl, I-V(ZN)HH, OM2, 12 vlakana	m	20 %	1.525,20
426)		0000000374	R314470	MM Breakout kabl, I-V(ZN)HH, OM2, 16 vlakana	m	20 %	1.662,10
427)		0000000375	R314246	MM Breakout kabl, I-V(ZN)HH, OM2, 24 vlakana	m	20 %	2.676,91







428)		0000000376	R314472	MM Breakout kabl, I-V(ZN)HH, OM3, 2 vlakna	m	20 %	610,08
429)		0000000377	R314473	MM Breakout kabl, I-V(ZN)HH, OM3, 4 vlakna	m	20 %	755,90
430)		0000000378	R314474	MM Breakout kabl, I-V(ZN)HH, OM3, 6 vlakana	m	20 %	983,57
431)		0000000379	R314241	MM Breakout kabl, I-V(ZN)HH, OM3, 8 vlakana	m	20 %	1.333,25
432)		0000000380	R314244	MM Breakout kabl, I-V(ZN)HH, OM3, 12 vlakana	m	20 %	1.959,70
433)		0000000381	R314244	MM Breakout kabl, I-V(ZN)HH, OM3, 16 vlakana	m	20 %	1.959,70







434)		0000000382 R314247	MM Breakout kabl, I-V(ZN)HH, OM3, 24 vlakana	m	20 %	3.353,95
435)		0000000383 R512701	MM Breakout kabl, I-V(ZN)HH, OM4, 8 vlakana	m	20 %	1.483,54
436)		0000000384 R512702	MM Breakout kabl, I-V(ZN)HH, OM4, 12 vlakana	m	20 %	2.098,08
437)		0000000385 R512703	MM Breakout kabl, I-V(ZN)HH, OM4, 24 vlakana	m	20 %	3.932,78

#### Mini Breakout I-V(ZN=B)H

Proizvođač: Reichle & De-Massari





	Web šifra	Kat.oznaka	Naziv proizvoda	Jed.mere	PDV	Cena (din)
438)		0000000411 R314492	SM Mini breakout kabl, I-V(ZN=B)H, G.652.D, 2 vlakna, OS2	m	20 %	150,29







439)		0000000412	R304135	SM Mini breakout kabl, I-V(ZN=B)H, G.652.D, 4 vlakna, OS2	m	20 %	199,39
440)		0000000413	R304136	SM Mini breakout kabl, I-V(ZN=B)H, G.652.D, 6 vlakana, OS2	m	20 %	235,10
441)		0000000414	R304137	SM Mini breakout kabl, I-V(ZN=B)H, G.652.D, 8 vlakana, OS2	m	20 %	300,58
442)		0000000415	R304138	SM Mini breakout kabl, I-V(ZN=B)H, G.652.D, 12 vlakana, OS2	m	20 %	407,71
443)		0000000416	R314493	SM Mini breakout kabl, I-V(ZN=B)H, G.652.D, 16 vlakana, OS2	m	20 %	513,36
444)		0000000417	R304140	SM Mini breakout kabl, I-V(ZN=B)H, G.652.D, 24 vlakana, OS2	m	20 %	785,66

445)		0000000439	R512709	SM Mini breakout kabl, I-V(ZN=B)H, G.657, 4 vlakna	m	20 %	617,52
446)		0000000440	R512710	SM Mini breakout kabl, I-V(ZN=B)H, G.657, 6 vlakana	m	20 %	813,94
447)		0000000441	R512711	SM Mini breakout kabl, I-V(ZN=B)H, G.657, 8 vlakna	m	20 %	971,66
448)		0000000442	R512712	SM Mini breakout kabl, I-V(ZN=B)H, G.657, 12 vlakna	m	20 %	1.376,40
449)		0000000443	R512713	SM Mini breakout kabl, I-V(ZN=B)H, G.657, 24 vlakna	m	20 %	2.385,26
450)		0000000418	R314486	MM Mini breakout kabl, I-V(ZN=B)H, OM1, 2 vlakna	m	20 %	157,73

451)		0000000419	R304081	MM Mini breakout kabl, I-V(ZN=B)H, OM1, 4 vlakna	m	20 %	223,20
452)		0000000420	R304082	MM Mini breakout kabl, I-V(ZN=B)H, OM1, 6 vlakana	m	20 %	299,09
453)		0000000421	R304083	MM Mini breakout kabl, I-V(ZN=B)H, OM1, 8 vlakana	m	20 %	369,02
454)		0000000422	R304084	MM Mini breakout kabl, I-V(ZN=B)H, OM1, 12 vlakana	m	20 %	510,38
455)		0000000423	R314487	MM Mini breakout kabl, I-V(ZN=B)H, OM1, 16 vlakana	m	20 %	684,48
456)		0000000424	R304086	MM Mini breakout kabl, I-V(ZN=B)H, OM1, 24 vlakana	m	20 %	1.069,87

457)		0000000425	R314488	MM Mini breakout kabl, I-V(ZN=B)H, OM2, 2 vlakna	m	20 %	177,07
458)		0000000426	R304073	MM Mini breakout kabl, I-V(ZN=B)H, OM2, 4 vlakna	m	20 %	226,18
459)		0000000427	R304074	MM Mini breakout kabl, I-V(ZN=B)H, OM2, 6 vlakana	m	20 %	303,55
460)		0000000428	R304075	MM Mini breakout kabl, I-V(ZN=B)H, OM2, 8 vlakana	m	20 %	369,02
461)		0000000429	R304076	MM Mini breakout kabl, I-V(ZN=B)H, OM2, 12 vlakana	m	20 %	529,73
462)		0000000430	R314489	MM Mini breakout kabl, I-V(ZN=B)H, OM2, 16 vlakana	m	20 %	674,06

463)		0000000431	R304078	MM Mini breakout kabl, I-V(ZN=B)H, OM2, 24 vlakana	m	20 %	1.032,67
464)		0000000432	R314490	MM Mini breakout kabl, I-V(ZN=B)H, OM3, 2 vlakna	m	20 %	235,10
465)		0000000433	R308315	MM Mini breakout kabl, I-V(ZN=B)H, OM3, 4 vlakna	m	20 %	374,98
466)		0000000434	R308316	MM Mini breakout kabl, I-V(ZN=B)H, OM3, 6 vlakna	m	20 %	507,41
467)		0000000435	R308313	MM Mini breakout kabl, I-V(ZN=B)H, OM3, 8 vlakna	m	20 %	627,94
468)		0000000436	R308318	MM Mini breakout kabl, I-V(ZN=B)H, OM3, 12 vlakna	m	20 %	918,10





469)		0000000437	R314491	MM Mini breakout kabl, I-V(ZN=B)H, OM3, 16 vlakna	m	20 %	1.166,59
470)		0000000438	R308317	MM Mini breakout kabl, I-V(ZN=B)H, OM3, 24 vlakna	m	20 %	1.876,37
471)		0000000444	R512704	MM Mini breakout kabl, I-V(ZN=B)H, OM4, 4 vlakna	m	20 %	410,69
472)		0000000445	R512705	MM Mini breakout kabl, I-V(ZN=B)H, OM4, 6 vlakana	m	20 %	605,62
473)		0000000446	R512706	MM Mini breakout kabl, I-V(ZN=B)H, OM4, 8 vlakana	m	20 %	773,76
474)		0000000447	R512707	MM Mini breakout kabl, I-V(ZN=B)H, OM4, 12 vlakana	m	20 %	1.089,22







475)		0000000448 R512708	MM Mini breakout kabl, I-V(ZN=B)H, OM4, 24 vlakana	m	20 %	2.034,10
------	---	--------------------	--	---	------	----------







**Central Loose Tube I/A-DQ(ZN=B)H**



**Proizvođač: Reichle & De-Massari**

		Web šifra	Kat.oznaka	Naziv proizvoda	Jed.mere	PDV	Cena (din)
476)		0000000449	R304143	SM central loose tube kabl, I/A-DQ(ZN=B)H, G.652.D, 4 vlakna, OS2	m	20 %	169,63
477)		0000000450	R304145	SM central loose tube kabl, I/A-DQ(ZN=B)H, G.652.D, 6 vlakana, OS2	m	20 %	199,39
478)		0000000451	R304146	SM central loose tube kabl, I/A-DQ(ZN=B)H, G.652.D, 8 vlakana, OS2	m	20 %	215,76
479)		0000000452	R304147	SM central loose tube kabl, I/A-DQ(ZN=B)H, G.652.D, 12 vlakana, OS2	m	20 %	269,33

480)		0000000453	R304148	SM central loose tube kabl, I/A-DQ(ZN=B)H, G.652.D, 24 vlakana, OS2	m	20 %	440,45
481)		0000000454	R304093	MM central loose tube kabl, I/A-DQ(ZN=B)H, OM1, 4 vlakna	m	20 %	223,20
482)		0000000455	R304094	MM central loose tube kabl, I/A-DQ(ZN=B)H, OM1, 6 vlakana	m	20 %	319,92
483)		0000000456	R304095	MM central loose tube kabl, I/A-DQ(ZN=B)H, OM1, 8 vlakana	m	20 %	377,95
484)		0000000457	R304096	MM central loose tube kabl, I/A-DQ(ZN=B)H, OM1, 12 vlakana	m	20 %	529,73
485)		0000000458	R304097	MM central loose tube kabl, I/A-DQ(ZN=B)H, OM1, 24 vlakana	m	20 %	925,54



486)		0000000459	R304088	MM central loose tube kabl, I/A-DQ(ZN=B)H, OM2, 4 vlakna	m	20 %	226,18
487)		0000000460	R304089	MM central loose tube kabl, I/A-DQ(ZN=B)H, OM2, 6 vlakana	m	20 %	276,77
488)		0000000461	R304090	MM central loose tube kabl, I/A-DQ(ZN=B)H, OM2, 8 vlakana	m	20 %	346,70
489)		0000000462	R304091	MM central loose tube kabl, I/A-DQ(ZN=B)H, OM2, 12 vlakana	m	20 %	459,79
490)		0000000463	R304092	MM central loose tube kabl, I/A-DQ(ZN=B)H, OM2, 24 vlakana	m	20 %	775,25
491)		0000000464	R308217	MM central loose tube kabl, I/A-DQ(ZN=B)H, OM3, 4 vlakna	m	20 %	361,58







492)		0000000465	R308310	MM central loose tube kabl, I/A-DQ(ZN=B)H, OM3, 6 vlakana	m	20 %	464,26
493)		0000000466	R308218	MM central loose tube kabl, I/A-DQ(ZN=B)H, OM3, 8 vlakana	m	20 %	541,63
494)		0000000467	R308214	MM central loose tube kabl, I/A-DQ(ZN=B)H, OM3, 12 vlakana	m	20 %	806,50
495)		0000000468	R308215	MM central loose tube kabl, I/A-DQ(ZN=B)H, OM3, 24 vlakana	m	20 %	1.534,13
496)		0000000469	R512391	MM central loose tube kabl, I/A-DQ(ZN=B)H, OM4, 4 vlakna	m	20 %	416,64
497)		0000000470	R512392	MM central loose tube kabl, I/A-DQ(ZN=B)H, OM4, 6 vlakana	m	20 %	590,74





498)		0000000471	R512393	MM central loose tube kabl, I/A-DQ(ZN=B)H, OM4, 8 vlakana	m	20 %	680,02
499)		0000000472	R512394	MM central loose tube kabl, I/A-DQ(ZN=B)H, OM4, 12 vlakana	m	20 %	971,66
500)		0000000473	R512395	MM central loose tube kabl, I/A-DQ(ZN=B)H, OM4, 24 vlakana	m	20 %	1.663,58

**Stranded Loose Tube I/A-DQ(ZN=B)H**

**Proizvođač: Reichle & De-Massari**

	<b>Web šifra</b>	<b>Kat.oznaka</b>	<b>Naziv proizvoda</b>	<b>Jed.mere</b>	<b>PDV</b>	<b>Cena (din)</b>	
501)		0000000474	R314513	SM stranded loose tube kabl, I/A-DQ(ZN=B)H, G.652.D, 1x12 vlakana, OS2	m	20 %	441,94
502)		0000000475	R314514	SM stranded loose tube kabl, I/A-DQ(ZN=B)H, G.652.D, 2x12 vlakana, OS2	m	20 %	596,69

503)		0000000476	R314515	SM stranded loose tube kabl, I/A-DQ(ZN=B)H, G.652.D, 4x12 vlakana, OS2	m	20 %	827,33
504)		0000000477	R314516	SM stranded loose tube kabl, I/A-DQ(ZN=B)H, G.652.D, 6x12 vlakana, OS2	m	20 %	958,27
505)		0000000478	R314517	SM stranded loose tube kabl, I/A-DQ(ZN=B)H, G.652.D, 8x12 vlakana, OS2	m	20 %	1.215,70
506)		0000000479	R314518	SM stranded loose tube kabl, I/A-DQ(ZN=B)H, G.652.D, 12x12 vlakana, OS2	m	20 %	1.730,54
507)		0000000480	R314494	MM stranded loose tube kabl, I/A-DQ(ZN=B)H, OM1, 1x12 vlakana	m	20 %	662,16
508)		0000000481	R314495	MM stranded loose tube kabl, I/A-DQ(ZN=B)H, OM1, 2x12 vlakana	m	20 %	1.032,67

509)		0000000482	R314497	MM stranded loose tube kabl, I/A-DQ(ZN=B)H, OM1, 4x12 vlakana	m	20 %	1.711,20
510)		0000000483	R314498	MM stranded loose tube kabl, I/A-DQ(ZN=B)H, OM1, 6x12 vlakana	m	20 %	2.346,58
511)		0000000484	R314499	MM stranded loose tube kabl, I/A-DQ(ZN=B)H, OM1, 8x12 vlakana	m	20 %	3.063,79
512)		0000000485	R314500	MM stranded loose tube kabl, I/A-DQ(ZN=B)H, OM1, 12x12 vlakana	m	20 %	4.443,17
513)		0000000486	R314501	MM stranded loose tube kabl, I/A-DQ(ZN=B)H, OM2, 1x12 vlakana	m	20 %	668,11
514)		0000000487	R314502	MM stranded loose tube kabl, I/A-DQ(ZN=B)H, OM2, 2x12 vlakana	m	20 %	989,52

515)		0000000488	R314503	MM stranded loose tube kabl, I/A-DQ(ZN=B)H, OM2, 4x12 vlakana	m	20 %	1.568,35
516)		0000000489	R314504	MM stranded loose tube kabl, I/A-DQ(ZN=B)H, OM2, 6x12 vlakana	m	20 %	2.111,47
517)		0000000490	R314505	MM stranded loose tube kabl, I/A-DQ(ZN=B)H, OM2, 8x12 vlakana	m	20 %	2.736,43
518)		0000000491	R314506	MM stranded loose tube kabl, I/A-DQ(ZN=B)H, OM2, 12x12 vlakana	m	20 %	3.919,39
519)		0000000492	R314507	MM stranded loose tube kabl, I/A-DQ(ZN=B)H, OM3, 1x12 vlakana	m	20 %	1.141,30
520)		0000000493	R314508	MM stranded loose tube kabl, I/A-DQ(ZN=B)H, OM3, 2x12 vlakana	m	20 %	1.907,62







521)		0000000494 R314509	MM stranded loose tube kabl, I/A-DQ(ZN=B)H, OM3, 4x12 vlakana	m	20 %	3.282,53
522)		0000000495 R314510	MM stranded loose tube kabl, I/A-DQ(ZN=B)H, OM3, 6x12 vlakana	m	20 %	4.661,90
523)		0000000496 R314511	MM stranded loose tube kabl, I/A-DQ(ZN=B)H, OM3, 8x12 vlakana	m	20 %	6.136,51
524)		0000000497 R314512	MM stranded loose tube kabl, I/A-DQ(ZN=B)H, OM3, 12x12 vlakana	m	20 %	9.027,70





**Central Loose Tube A-DQ(ZN)B2Y**







**Proizvođač: Reichle & De-Massari**



	<b>Web šifra</b>	<b>Kat.oznaka</b>	<b>Naziv proizvoda</b>	<b>Jed.mere</b>	<b>PDV</b>	<b>Cena (din)</b>
525)		0000000387 R314525	SM central loose tube kabl, A-DQ(ZN)B2Y, G.652.D, 4 vlakna, OS2	m	20 %	199,39

526)		0000000388	R312797	SM central loose tube kabl, A-DQ(ZN)B2Y, G.652.D, 6 vlakana, OS2	m	20 %	315,46
527)		0000000386	R314526	SM central loose tube kabl, A-DQ(ZN)B2Y, G.652.D, 8 vlakana, OS2	m	20 %	241,06
528)		0000000389	R304156	SM central loose tube kabl, A-DQ(ZN)B2Y, G.652.D, 12 vlakana, OS2	m	20 %	296,11
529)		0000000390	R314527	SM central loose tube kabl, A-DQ(ZN)B2Y, G.652.D, 24 vlakana, OS2	m	20 %	380,93
530)		0000000391	R314519	MM central loose tube kabl, A-DQ(ZN)B2Y, OM1, 4 vlakna	m	20 %	239,57
531)		0000000392	R312789	MM central loose tube kabl, A-DQ(ZN)B2Y, OM1, 6 vlakana	m	20 %	293,14

532)		0000000393	R314520	MM central loose tube kabl, A-DQ(ZN)B2Y, OM1, 8 vlakana	m	20 %	336,29
533)		0000000394	R304153	MM central loose tube kabl, A-DQ(ZN)B2Y, OM1, 12 vlakana	m	20 %	456,82
534)		0000000395	R304154	MM central loose tube kabl, A-DQ(ZN)B2Y, OM1, 24 vlakana	m	20 %	803,52
535)		0000000396	R314521	MM central loose tube kabl, A-DQ(ZN)B2Y, OM2, 4 vlakna	m	20 %	233,62
536)		0000000397	R312791	MM central loose tube kabl, A-DQ(ZN)B2Y, OM2, 6 vlakana	m	20 %	290,16
537)		0000000398	R314522	MM central loose tube kabl, A-DQ(ZN)B2Y, OM2, 8 vlakana	m	20 %	319,92



538)		0000000399	R314150	MM central loose tube kabl, A-DQ(ZN)B2Y, OM2, 12 vlakana	m	20 %	395,81
539)		0000000400	R314151	MM central loose tube kabl, A-DQ(ZN)B2Y, OM2, 24 vlakana	m	20 %	674,06
540)		0000000401	R314523	MM central loose tube kabl, A-DQ(ZN)B2Y, OM3, 4 vlakna	m	20 %	380,93
541)		0000000402	R312792	MM central loose tube kabl, A-DQ(ZN)B2Y, OM3, 6 vlakna	m	20 %	467,23
542)		0000000403	R314524	MM central loose tube kabl, A-DQ(ZN)B2Y, OM3, 8 vlakna	m	20 %	572,88
543)		0000000404	R311387	MM central loose tube kabl, A-DQ(ZN)B2Y, OM3, 12 vlakna	m	20 %	827,33

544)		0000000405	R311388	MM central loose tube kabl, A-DQ(ZN)B2Y, OM3, 24 vlakna	m	20 %	1.336,22
545)		0000000406	R512396	MM central loose tube kabl, A-DQ(ZN)B2Y, OM4, 4 vlakna	m	20 %	416,64
546)		0000000407	R512397	MM central loose tube kabl, A-DQ(ZN)B2Y, OM4, 6 vlakana	m	20 %	566,93
547)		0000000408	R512398	MM central loose tube kabl, A-DQ(ZN)B2Y, OM4, 8 vlakana	m	20 %	680,02
548)		0000000409	R512399	MM central loose tube kabl, A-DQ(ZN)B2Y, OM4, 12 vlakana	m	20 %	971,66
549)		0000000410	R512400	MM central loose tube kabl, A-DQ(ZN)B2Y, OM4, 24 vlakana	m	20 %	1.663,58



550)		0000001289 R304157	SM central loose tube kabl, A-DQ(ZN)B2Y, G.652.D, 24 vlakana, OS2	m	20 %	459,79
551)		0000001290 R304150	MM central loose tube kabl, A-DQ(ZN)B2Y, OM2, 12 vlakana	m	20 %	461,28
552)		0000001291 R304151	MM central loose tube kabl, A-DQ(ZN)B2Y, OM2, 24 vlakana	m	20 %	781,20

#### Stranded Loose Tube A-DQ(ZN)B2Y

Proizvođač: Reichle & De-Massari

	Web šifra	Kat.oznaka	Naziv proizvoda	Jed.mere	PDV	Cena (din)
553)		0000000498 R314542	SM stranded loose tube kabl, A-DQ(ZN)B2Y, G.652.D, 1x12 vlakana, OS2	m	20 %	372,00
554)		0000000499 R314451	SM stranded loose tube kabl, A-DQ(ZN)B2Y, G.652.D, 2x12 vlakana, OS2	m	20 %	531,22

555)		0000000500	R304158	SM stranded loose tube kabl, A-DQ(ZN)B2Y, G.652.D, 4x12 vlakana, OS2	m	20 %	752,93
556)		0000000501	R314452	SM stranded loose tube kabl, A-DQ(ZN)B2Y, G.652.D, 6x12 vlakana, OS2	m	20 %	931,49
557)		0000000502	R314453	SM stranded loose tube kabl, A-DQ(ZN)B2Y, G.652.D, 8x12 vlakana, OS2	m	20 %	1.133,86
558)		0000000503	R314454	SM stranded loose tube kabl, A-DQ(ZN)B2Y, G.652.D, 12x12 vlakana, OS2	m	20 %	1.556,45
559)		0000000504	R314527	MM stranded loose tube kabl, A-DQ(ZN)B2Y, OM1, 1x12 vlakana	m	20 %	575,86
560)		0000000505	R314528	MM stranded loose tube kabl, A-DQ(ZN)B2Y, OM1, 2x12 vlakana	m	20 %	924,05

561)		0000000506	R304155	MM stranded loose tube kabl, A-DQ(ZN)B2Y, OM1, 4x12 vlakana	m	20 %	1.569,84
562)		0000000507	R314529	MM stranded loose tube kabl, A-DQ(ZN)B2Y, OM1, 6x12 vlakana	m	20 %	2.237,95
563)		0000000508	R314530	MM stranded loose tube kabl, A-DQ(ZN)B2Y, OM1, 8x12 vlakana	m	20 %	2.840,59
564)		0000000509	R314531	MM stranded loose tube kabl, A-DQ(ZN)B2Y, OM1, 12x12 vlakana	m	20 %	4.133,66
565)		0000000510	R314532	MM stranded loose tube kabl, A-DQ(ZN)B2Y, OM2, 1x12 vlakana	m	20 %	522,29
566)		0000000511	R314533	MM stranded loose tube kabl, A-DQ(ZN)B2Y, OM2, 2x12 vlakana	m	20 %	839,23

567)		0000000512	R304152	MM stranded loose tube kabl, A-DQ(ZN)B2Y, OM2, 4x12 vlakana	m	20 %	1.361,52
568)		0000000513	R314534	MM stranded loose tube kabl, A-DQ(ZN)B2Y, OM2, 6x12 vlakana	m	20 %	1.776,67
569)		0000000514	R314535	MM stranded loose tube kabl, A-DQ(ZN)B2Y, OM2, 8x12 vlakana	m	20 %	2.316,82
570)		0000000515	R314536	MM stranded loose tube kabl, A-DQ(ZN)B2Y, OM2, 12x12 vlakana	m	20 %	3.330,14
571)		0000000516	R314537	MM stranded loose tube kabl, A-DQ(ZN)B2Y, OM3, 1x12 vlakana	m	20 %	938,93
572)		0000000517	R314538	MM stranded loose tube kabl, A-DQ(ZN)B2Y, OM3, 2x12 vlakana	m	20 %	1.691,86



573)		0000000518 R311389	MM stranded loose tube kabl, A-DQ(ZN)B2Y, OM3, 4x12 vlakana	m	20 %	2.941,78
574)		0000000519 R314539	MM stranded loose tube kabl, A-DQ(ZN)B2Y, OM3, 6x12 vlakana	m	20 %	4.283,95
575)		0000000520 R314540	MM stranded loose tube kabl, A-DQ(ZN)B2Y, OM3, 8x12 vlakana	m	20 %	5.557,68
576)		0000000522 R314541	MM stranded loose tube kabl, A-DQ(ZN)B2Y, OM3, 12x12 vlakana	m	20 %	7.794,14



**Central Loose Tube A-D(ZN)W2Y**

**Proizvođač: Reichle & De-Massari**

	Web šifra	Kat.oznaka	Naziv proizvoda	Jed.mere	PDV	Cena (din)
577)		0000000523 R312793	SM central loose tube kabl, A-D(ZN)W2Y, G.652.D, 6 vlakana, OS2	m	20 %	288,67



578)		0000000524	R314543	SM central loose tube kabl, A-D(ZN)W2Y, G.652.D, 8 vlakana, OS2	m	20 %	302,06
579)		0000000525	R304216	SM central loose tube kabl, A-D(ZN)W2Y, G.652.D, 12 vlakana, OS2	m	20 %	321,41
580)		0000000526	R304217	SM central loose tube kabl, A-D(ZN)W2Y, G.652.D, 24 vlakana, OS2	m	20 %	446,40
581)		0000000527	R312796	MM central loose tube kabl, A-D(ZN)W2Y, OM1, 6 vlakana	m	20 %	352,66
582)		0000000528	R314455	MM central loose tube kabl, A-D(ZN)W2Y, OM1, 8 vlakana	m	20 %	395,81
583)		0000000529	R304213	MM central loose tube kabl, A-D(ZN)W2Y, OM1, 12 vlakana	m	20 %	489,55





584)		0000000530	R304214	MM central loose tube kabl, A-D(ZN)W2Y, OM1, 24 vlakana	m	20 %	809,47
585)		0000000531	R312795	MM central loose tube kabl, A-D(ZN)W2Y, OM2, 6 vlakana	m	20 %	360,10
586)		0000000532	R314456	MM central loose tube kabl, A-D(ZN)W2Y, OM2, 8 vlakana	m	20 %	383,90
587)		0000000533	R304210	MM central loose tube kabl, A-D(ZN)W2Y, OM2, 12 vlakana	m	20 %	467,23
588)		0000000534	R304211	MM central loose tube kabl, A-D(ZN)W2Y, OM2, 24 vlakana	m	20 %	755,90
589)		0000000535	R312794	MM central loose tube kabl, A-D(ZN)W2Y, OM3, 6 vlakana	m	20 %	550,56







590)		0000000536 R314457	MM central loose tube kabl, A-D(ZN)W2Y, OM3, 8 vlakana	m	20 %	675,55
591)		0000000537 R311390	MM central loose tube kabl, A-D(ZN)W2Y, OM3, 12 vlakana	m	20 %	855,60
592)		0000000538 R311391	MM central loose tube kabl, A-D(ZN)W2Y, OM3, 24 vlakana	m	20 %	1.543,06







**Stranded Loose Tube A-DF(ZN)2YW2Y**

**Proizvođač: Reichle & De-Massari**

		<b>Web šifra</b>	<b>Kat.oznaka</b>	<b>Naziv proizvoda</b>	<b>Jed.mere</b>	<b>PDV</b>	<b>Cena (din)</b>
593)		0000000539	R314556	SM stranded loose tube kabl, A-DF(ZN)2YW2Y, G.652.D, 1x12 vlakana, OS2	m	20 %	492,53
594)		0000000540	R314557	SM stranded loose tube kabl, A-DF(ZN)2YW2Y, G.652.D, 2x12 vlakana, OS2	m	20 %	623,47





595)		0000000541	R304218	SM stranded loose tube kabl, A-DF(ZN)2YW2Y, G.652.D, 4x12 vlakana, OS2	m	20 %	839,23
596)		0000000542	R314558	SM stranded loose tube kabl, A-DF(ZN)2YW2Y, G.652.D, 6x12 vlakana, OS2	m	20 %	1.007,38
597)		0000000543	R314559	SM stranded loose tube kabl, A-DF(ZN)2YW2Y, G.652.D, 8x12 vlakana, OS2	m	20 %	1.303,49
598)		0000000544	R314544	MM stranded loose tube kabl, A-DF(ZN)2YW2Y, OM1, 1x12 vlakana	m	20 %	645,79
599)		0000000545	R314545	MM stranded loose tube kabl, A-DF(ZN)2YW2Y, OM1, 2x12 vlakana	m	20 %	977,62
600)		0000000546	R304215	MM stranded loose tube kabl, A-DF(ZN)2YW2Y, OM1, 4x12 vlakana	m	20 %	1.596,62





601)		0000000547	R314546	MM stranded loose tube kabl, A-DF(ZN)2YW2Y, OM1, 6x12 vlakana	m	20 %	2.172,48
602)		0000000548	R314547	MM stranded loose tube kabl, A-DF(ZN)2YW2Y, OM1, 8x12 vlakana	m	20 %	2.818,27
603)		0000000549	R314548	MM stranded loose tube kabl, A-DF(ZN)2YW2Y, OM2, 1x12 vlakana	m	20 %	654,72
604)		0000000550	R314549	MM stranded loose tube kabl, A-DF(ZN)2YW2Y, OM2, 2x12 vlakana	m	20 %	938,93
605)		0000000551	R304212	MM stranded loose tube kabl, A-DF(ZN)2YW2Y, OM2, 4x12 vlakana	m	20 %	1.479,07
606)		0000000552	R314550	MM stranded loose tube kabl, A-DF(ZN)2YW2Y, OM2, 6x12 vlakana	m	20 %	1.965,65







607)		0000000553	R314551	MM stranded loose tube kabl, A-DF(ZN)2YW2Y, OM2, 8x12 vlakana	m	20 %	2.520,67
608)		0000000554	R314552	MM stranded loose tube kabl, A-DF(ZN)2YW2Y, OM3, 1x12 vlakana	m	20 %	1.040,11
609)		0000000555	R314553	MM stranded loose tube kabl, A-DF(ZN)2YW2Y, OM3, 2x12 vlakana	m	20 %	1.720,13
610)		0000000556	R311392	MM stranded loose tube kabl, A-DF(ZN)2YW2Y, OM3, 4x12 vlakana	m	20 %	3.023,62
611)		0000000557	R314554	MM stranded loose tube kabl, A-DF(ZN)2YW2Y, OM3, 6x12 vlakana	m	20 %	4.278,00
612)		0000000558	R314555	MM stranded loose tube kabl, A-DF(ZN)2YW2Y, OM3, 8x12 vlakana	m	20 %	5.606,78



Stranded Loose Tube A-DF(ZN)2YQ(ZN)2Y, ADSS

Proizvođač: Reichle & De-Massari

	Web šifra	Kat.oznaka	Naziv proizvoda	Jed.mere	PDV	Cena (din)
613)		0000000559 R314575	SM stranded loose tube kabl, A-DF(ZN)2YQ(ZN)2Y, G.652.D, 1x12 vlakana, OS2, ADSS	m	20 %	654,72
614)		0000000560 R314576	SM stranded loose tube kabl, A-DF(ZN)2YQ(ZN)2Y, G.652.D, 2x12 vlakana, OS2, ADSS	m	20 %	937,44
615)		0000000561 R314577	SM stranded loose tube kabl, A-DF(ZN)2YQ(ZN)2Y, G.652.D, 4x12 vlakana, OS2, ADSS	m	20 %	1.136,83
616)		0000000562 R314578	SM stranded loose tube kabl, A-DF(ZN)2YQ(ZN)2Y, G.652.D, 6x12 vlakana, OS2, ADSS	m	20 %	1.288,61
617)		0000000563 R314579	SM stranded loose tube kabl, A-DF(ZN)2YQ(ZN)2Y, G.652.D, 8x12 vlakana, OS2, ADSS	m	20 %	1.535,62

618)		0000000564	R314560	MM stranded loose tube kabl, A-DF(ZN)2YQ(ZN)2Y, OM1, 1x12 vlakana, ADSS	m	20 %	1.080,29
619)		0000000565	R314561	MM stranded loose tube kabl, A-DF(ZN)2YQ(ZN)2Y, OM1, 2x12 vlakana, ADSS	m	20 %	1.438,90
620)		0000000566	R314562	MM stranded loose tube kabl, A-DF(ZN)2YQ(ZN)2Y, OM1, 4x12 vlakana, ADSS	m	20 %	2.129,33
621)		0000000567	R314563	MM stranded loose tube kabl, A-DF(ZN)2YQ(ZN)2Y, OM1, 6x12 vlakana, ADSS	m	20 %	2.764,70
622)		0000000568	R314564	MM stranded loose tube kabl, A-DF(ZN)2YQ(ZN)2Y, OM1, 8x12 vlakana, ADSS	m	20 %	3.498,29
623)		0000000569	R314565	MM stranded loose tube kabl, A-DF(ZN)2YQ(ZN)2Y, OM2, 1x12 vlakana, ADSS	m	20 %	1.071,36

624)		0000000570	R314566	MM stranded loose tube kabl, A-DF(ZN)2YQ(ZN)2Y, OM2, 2x12 vlakana, ADSS	m	20 %	1.365,98
625)		0000000571	R314567	MM stranded loose tube kabl, A-DF(ZN)2YQ(ZN)2Y, OM2, 4x12 vlakana, ADSS	m	20 %	1.910,59
626)		0000000572	R314568	MM stranded loose tube kabl, A-DF(ZN)2YQ(ZN)2Y, OM2, 6x12 vlakana, ADSS	m	20 %	2.413,54
627)		0000000573	R314569	MM stranded loose tube kabl, A-DF(ZN)2YQ(ZN)2Y, OM2, 8x12 vlakana, ADSS	m	20 %	3.005,76
628)		0000000574	R314570	MM stranded loose tube kabl, A-DF(ZN)2YQ(ZN)2Y, OM3, 1x12 vlakana, ADSS	m	20 %	1.459,73
629)		0000000575	R314571	MM stranded loose tube kabl, A-DF(ZN)2YQ(ZN)2Y, OM3, 2x12 vlakana, ADSS	m	20 %	2.156,11

630)		0000000576 R314572	MM stranded loose tube kabl, A-DF(ZN)2YQ(ZN)2Y, OM3, 4x12 vlakana, ADSS	m	20 %	3.498,29
631)		0000000578 R314573	MM stranded loose tube kabl, A-DF(ZN)2YQ(ZN)2Y, OM3, 6x12 vlakana, ADSS	m	20 %	4.780,94
632)		0000000579 R314574	MM stranded loose tube kabl, A-DF(ZN)2YQ(ZN)2Y, OM3, 8x12 vlakana, ADSS	m	20 %	6.169,25

## Završne i prolazne optičke kutije

### Venus tip FML

Proizvođač: Reichle & De-Massari



	Web šifra	Kat.oznaka	Naziv proizvoda	Jed.mere	PDV	Cena (din)
633)		0000000638 R316551	Završna optička kutija Venus FML za 4xE-2000/SC, bez bravice	kom	20 %	5.359,78

634)		000000639	R316552	Završna optička kutija Venus FML za 4xE-2000/SC, sa bravicom	kom	20 %	5.868,67
635)		000000640	R316733	Završna optička kutija Venus FML za 2xLC-dupleks, bez bravice	kom	20 %	4.889,57
636)		000000641	R316734	Završna optička kutija Venus FML za 2xLC-dupleks, sa bravicom	kom	20 %	5.868,67
637)		000000642	R317243	Završna optička kutija Venus FML za 2xSC-dupleks, bez bravice	kom	20 %	4.791,36
638)		000000643	R317244	Završna optička kutija Venus FML za 2xSC-dupleks, sa bravicom	kom	20 %	5.752,61
639)		000000644	R316553	Završna optička kutija Venus FML za 2xSC-RJ, bez bravice	kom	20 %	4.285,44

640)		0000000645	R316554	Završna optička kutija Venus FML za 2xSC-RJ, sa bravicom	kom	20 %	5.868,67
641)		0000000646	R316555	Završna optička kutija Venus FML za 4xST/FC, bez bravice	kom	20 %	5.444,59
642)		0000000647	R316556	Završna optička kutija Venus FML za 4xST/FC, sa bravicom	kom	20 %	5.868,67

#### Venus tip FLA



Proizvođač: Reichle & De-Massari

	Web šifra	Kat.oznaka	Naziv proizvoda	Jed.mere	PDV	Cena (din)	
643)		0000000648	R309493	Prolazna optička kutija Venus FLA, bez bravice	kom	20 %	7.315,01
644)		0000000649	R310761	Prolazna optička kutija Venus FLA, sa bravicom	kom	20 %	8.785,15

645)		0000000650	R309491	Završna optička kutija Venus FLA za 12xE-2000, SC/6xLC-dupleks, bez bravice	kom	20 %	10.180,90
646)		0000000651	R309492	Završna optička kutija Venus FLA za 12xE-2000, SC/6xLC-dupleks, sa bravicom	kom	20 %	11.160,00
647)		0000000652	R309784	Završna optička kutija Venus FLA za 12xST, FC, bez bravice	kom	20 %	10.180,90
648)		0000000653	R309785	Završna optička kutija Venus FLA za 12xST, FC, sa bravicom	kom	20 %	11.160,00
649)		0000000654	R501211	Završna optička kutija Venus FLA za 24xE-2000, SC/12xLC-dupleks, bez bravice	kom	20 %	11.710,56
650)		0000000655	R501212	Završna optička kutija Venus FLA za 24xE-2000, SC/12xLC-dupleks, sa bravicom	kom	20 %	12.701,57



### Venus tip FLA/SCM

Proizvođač: Reichle & De-Massari

	Web šifra	Kat.oznaka	Naziv proizvoda	Jed.mere	PDV	Cena (din)
651)		000000656 R509485	Prolazna optička kutija Venus FLA/SCM za 144 splajseva, sa bravicom	kom	20 %	20.543,33
652)		000000657 R509486	Prolazna optička kutija Venus FLA/SCM za 144 splajseva, bez bravice	kom	20 %	19.171,39

### Venus tip HLA





Proizvođač: Reichle & De-Massari



	Web šifra	Kat.oznaka	Naziv proizvoda	Jed.mere	PDV	Cena (din)
653)		000000658 R309816	Prolazna optička kutija Venus HLA, bez bravice	kom	20 %	9.853,54
654)		000000659 R309817	Prolazna optička kutija Venus HLA, sa bravicom	kom	20 %	11.685,26

## Splajs optičke kutije - spoljašnje

### Splajs kutije tip SCM



Proizvođač: Reichle & De-Massari

	Web šifra	Kat.oznaka	Naziv proizvoda	Jed.mere	PDV	Cena (din)
655)		0000000581 R509553	Splajs kutija SCM za 576 splajseva, 1xoval 10xfix	kom	20 %	47.552,02
656)		0000000582 R509568	Splajs kutija SCM za 1152 splajseva, 1xoval 10xfix	kom	20 %	50.660,45
657)		0000000583 R509587	Splajs kutija SCM za 576 splajseva, 1xoval 6xfix 12xflex	kom	20 %	72.664,99
658)		0000000584 R509594	Splajs kutija SCM za 576 splajseva, 1xoval 6xfix 24xflex	kom	20 %	80.206,18

659)		0000000585	R509245	Splajs kutija SCM za 1152 splajseva, 1xoval 6xfix 12xflex	kom	20 %	78.146,78
660)		0000000586	R509601	Splajs kutija SCM za 1152 splajseva, 1xoval 6xfix 24xflex	kom	20 %	85.003,49



### Splajs kutije tip LC

**Proizvođač: Reichle & De-Massari**

		Web šifra	Kat.oznaka	Naziv proizvoda	Jed.mere	PDV	Cena (din)
661)		0000000587	R307020	Splajs kutija LC za 24 splajseva, &#216;108x332, 3x&#216;22	kom	20 %	15.751,97
662)		0000000588	R307021	Splajs kutija LC za 48 splajseva, &#216;125x380, 4x&#216;22	kom	20 %	19.180,32
663)		0000000589	R307022	Splajs kutija LC za 72 splajsa, &#216;140x390, 4x&#216;22	kom	20 %	21.921,22

### Splajs kutije tip RM

Proizvođač: Reichle & De-Massari

	Web šifra	Kat.oznaka	Naziv proizvoda	Jed.mere	PDV	Cena (din)
664)		000000590 R307023	Splajs kutija RM za 48 splajseva, &#216;132x332, 4x&#216;20	kom	20 %	21.659,33
665)		000000591 R307024	Splajs kutija RM za 72 splajsa, &#216;155x332, 4x&#216;20	kom	20 %	24.549,02
666)		000000592 R307025	Splajs kutija RM za 144 splajseva, &#216;178x430, 4x&#216;32 2x&#216;20	kom	20 %	28.885,06

### Splajs kutije tip FL

Proizvođač: Reichle & De-Massari

	Web šifra	Kat.oznaka	Naziv proizvoda	Jed.mere	PDV	Cena (din)
667)		000000593 R307026	Splajs kutija FL za 48 splajseva, &#216;140x332, 1xoval 2x&#216;20	kom	20 %	21.376,61

668)		0000000594 R307027	Splajs kutija FL za 72 splajsa, &#216;155x332, 1xoval 2x&#216;20	kom	20 %	23.980,61
669)		0000000595 R314294	Splajs kutija FL za 72 splajsa, &#216;155x332, 1xoval 4x&#216;20	kom	20 %	25.364,45
670)		0000000596 R307028	Splajs kutija FL za 144 splajseva, &#216;180x443, 1xoval 2x&#216;32 2x&#216;20	kom	20 %	33.941,28
671)		0000000597 R313156	Splajs kutija FL za 144 splajseva, &#216;180x443, 1xoval 4x&#216;20	kom	20 %	33.941,28
672)		0000000598 R308522	Splajs kutija FL za 288 splajseva, &#216;200x610, 1xoval 4x&#216;32 2x&#216;20	kom	20 %	41.119,39

### Splajs kutije tip FTTx

Proizvođač: Reichle & De-Massari

Web šifra	Kat.oznaka	Naziv proizvoda	Jed.mere	PDV	Cena (din)
-----------	------------	-----------------	----------	-----	------------





673)		0000000599	R314303	Splajs kutija FTTx za 48 splajseva, &#216;140x443, 1xoval 6xF&#216;10	kom	20 %	36.331,01
674)		0000000601	R314304	Splajs kutija FTTx za 72 splajseva, &#216;160x443, 1xoval 12xF&#216;10	kom	20 %	43.872,19
675)		0000000602	R314305	Splajs kutija FTTx za 144 splajseva, &#216;180x443, 1xoval 24xF&#216;10	kom	20 %	60.686,59
676)		0000000603	R316227	Splajs kutija FTTx za 144 splajseva, &#216;180x443, 1xoval 36xF&#216;10	kom	20 %	51.559,20
677)		0000000604	R316481	Splajs kutija FTTx za 288 splajseva, &#216;200x610, 1xoval 24xF&#216;12	kom	20 %	67.964,40
678)		0000000605	R314306	Splajs kutija FTTx za 48 splajseva, &#216;140x443, 1x&#216;15, 1x&#216;20, 6xF&#216;10,	kom	20 %	31.053,07

679)		0000000606	R314307	Splajs kutija FTTx za 72 splajsa, &#216;160x443, 1x&#216;15, 1x&#216;20, 12xF&#216;10,	kom	20 %	41.181,89
680)		0000000607	R314308	Splajs kutija FTTx za 144 splajseva, &#216;180x443, 1x&#216;32, 1x&#216;20, 24xF&#216;10,	kom	20 %	46.872,00
681)		0000000608	R316228	Splajs kutija FTTx za 144 splajseva, &#216;180x443, 1x&#216;32, 1x&#216;20, 36xF&#216;10,	kom	20 %	49.104,00
682)		0000000609	R316482	Splajs kutija FTTx za 144 splajseva, &#216;180x443, 2x&#216;42, 6xF&#216;17,	kom	20 %	41.013,74
683)		0000000610	R316480	Splajs kutija FTTx za 288 splajseva, &#216;200x610, 1x&#216;42, 1x&#216;20, 24xF&#216;12	kom	20 %	64.728,00
684)		0000000611	R316483	Splajs kutija FTTx za 288 splajseva, &#216;200x610, 4x&#216;42, 6xF&#216;17	kom	20 %	58.032,00

Splajs kutije tip GSC

Proizvođač: Reichle & De-Massari







	Web šifra	Kat.oznaka	Naziv proizvoda	Jed.mere	PDV	Cena (din)
685) 	0000001458	R814604	Splajs kutija GSC-D20/40-N-LT/4 za 96 splajseva	kom	20 %	16.326,34
686) 	0000001461	R814607	Splajs kutija GSC-D20/40-GV-LT/4 za 96 splajseva	kom	20 %	16.906,66
687) 	0000001459	R814605	Splajs kutija GSC-D20/50-N-LT/6 za 144 splajseva	kom	20 %	22.108,70
688) 	0000001462	R814608	Splajs kutija GSC-D20/50-GV-LT/6 za 144 splajseva	kom	20 %	22.828,90
689) 	0000001460	R814606	Splajs kutija GSC-D30/50-N-LT/12 za 288 splajseva	kom	20 %	39.012,38







690)		0000001463 R814609	Splajs kutija GSC-D30/50-GV-LT/12 za 288 splajseva	kom	20 %	39.735,55
691)		0000001464 R814628	Oprema za fiksiranje splajs kutija tipe GSC-D20 za čelično užje	kom	20 %	1.842,14
692)		0000001465 R814626	Oprema za fiksiranje splajs kutije tipa GSC-D20 za zid ili stub	kom	20 %	1.842,14
693)		0000001466 R814627	Oprema za fiksiranje splajs kutije tipa GSC-D30 za zid ili stub	kom	20 %	1.842,14

### Oprema za splajs kutije

**Proizvođač: Reichle & De-Massari**



	Web šifra	Kat.oznaka	Naziv proizvoda	Jed.mere	PDV	Cena (din)
694)		0000000600 R509376	Skupljač vlage (silikonski gel) 2 x 20 g	kom	20 %	779,71

695)		000000612	R30392	Skupljač vlage (silikonski gel) 2 x 60 g	kom	20 %	1.699,30
696)		000000613	R307029	Oprema za smanjenje zategnutosti kabla za splajs kutije	kom	20 %	1.118,98
697)		000000614	R509175	Oprema za uvod kablova - SCM, Backbone standard	kom	20 %	3.069,74
698)		000000615	R509172	Oprema za uvod kablova - SCM, Backbone loop	kom	20 %	5.672,26
699)		000000616	R509174	Oprema za uvod kablova - SCM, FTTx standard	kom	20 %	2.203,73
700)		000000617	R509170	Oprema za uvod kablova - SCM, FTTx loop	kom	20 %	3.682,80

701)		0000000618	R508327	Oprema za uvod kabla - SCM, &#216;28/6x150, 1x držač kabla	kom	20 %	1.419,55
702)		0000000619	R508326	Oprema za uvod kabla - SCM, &#216;31/8x150, 1x držač kabla	kom	20 %	1.419,55
703)		0000000620	R508325	Oprema za uvod kabla - SCM, Å~41/12x150, 1x držač kabla	kom	20 %	1.419,55
704)		0000000623	R508289	Oprema za uvod kabla - SCM, 6xflex	kom	20 %	741,02
705)		0000000624	R509342	Oprema za uvod kabla - SCM, &#216;28/6x150	kom	20 %	425,57
706)		0000000625	R307321	Oprema za uvod kabla - SCM, &#216;31/8x150	kom	20 %	425,57

707)		0000000626	R307322	Oprema za uvod kabla - SCM, &#216;41/12x150	kom	20 %	494,02
708)		0000000621	R308560	Oprema za uvod kabla - SCM, &#216;50/18x150	kom	20 %	494,02
709)		0000000622	R307323	Oprema za uvod kabla oval, &#216;75/23x150	kom	20 %	1.488,00
710)		0000000627	R307315	Oprema za montažu splajs kutije na zid ili na stub, za kutije &#216;140 mm	kom	20 %	3.955,10
711)		0000000628	R307316	Opema za montažu splajs kutije na zid ili na stub, za kutije &#216;160 mm	kom	20 %	4.240,80
712)		0000000629	R307317	Oprema za montažu splajs kutije na zid ili na stub, za kutije &#216;180 mm	kom	20 %	4.523,52



713)		0000000630	R508354	Oprema za montažu splajs kutije na zid ili na stub, za kutije &#216;250 mm	kom	20 %	8.038,18
714)		0000000631	R30738	Oprema za montažu splajs kutije na zid, za kutije od &#216;125 - &#216;200 mm	kom	20 %	331,82
715)		0000000632	R509392	Oprema za montažu splajs kutije na zid, za kutije od &#216;250 mm	kom	20 %	8.176,56
716)		0000000633	R303002	Kabl za uzemljenje tip V - &#216; 6 mm, 400 mm	kom	20 %	1.133,86
717)		0000000634	R303003	Kabl za uzemljenje tip V - tip V, 500 mm	kom	20 %	1.133,86
718)		0000000635	R303004	Kabl za uzemljenje tip V - tip V, 1000 mm	kom	20 %	1.133,86

719)		0000000636	R308561	Oprema za uzemljenje kablova sa čeličnim oklopom, &#216;22-6 mm	kom	20 %	4.097,95
720)		0000000637	R308562	Oprema za uzemljenje kablova sa čeličnim oklopom, &#216;32-10 mm	kom	20 %	4.523,52

## Optički prespojni paneli

### 19 inc SpliceBox





Proizvođač: Reichle & De-Massari







	Web šifra	Kat.oznaka	Naziv proizvoda	Jed.mere	PDV	Cena (din)	
721)		0000000700	R804625	19 inc 1U SpliceBoxsa 24xLC-dupleks konektorima, G.652.D, APC, keramika, C/1	kom	20 %	124.143,84
722)		0000000701	R804623	19 inc 1U SpliceBoxsa 24xLC-dupleks konektorima, G.652.D, PC, keramika, C/2	kom	20 %	99.234,72



723)		000000702	R804621	19 inc 1U SpliceBoxsa 24xLC-dupleks konektorima, OM3, PC, keramika, Bm/3	kom	20 %	65.352,96
724)		000000703	R804619	19 inc 1U SpliceBoxsa 24xLC-dupleks konektorima, OM4, PC, keramika, Bm/3	kom	20 %	71.513,28
725)		000000704	R804626	19 inc 1U SpliceBoxsa 24xSC-dupleks konektorima, G.652.D, APC, keramika, C/1	kom	20 %	102.448,80
726)		000000705	R804624	19 inc 1U SpliceBoxsa 24xSC-dupleks konektorima, G.652.D, PC, keramika, C/2	kom	20 %	99.234,72
727)		000000706	R804622	19 inc 1U SpliceBoxsa 24xSC-dupleks konektorima, OM3, PC, keramika, Bm/3	kom	20 %	64.415,52
728)		000000707	R804620	19 inc 1U SpliceBoxsa 24xSC-dupleks konektorima, OM4, PC, keramika, Bm/3	kom	20 %	69.236,64

19 inc UniRack

Proizvođač: Reichle & De-Massari



	Web šifra	Kat.oznaka	Naziv proizvoda	Jed.mere	PDV	Cena (din)
729) 	000000708	R308473	19 inc 1U UniRack sa 12xE-2000 konektorima, G.652.D, APC, keramika, C/1, pod uglom 45° ulevo	kom	20 %	80.185,34
730) 	000000710	R308474	19 inc 2U UniRack sa 24xE-2000 konektorima, G.652.D, APC, keramika, C/1, pod uglom 45° ulevo	kom	20 %	155.397,79
731) 	000000709	R303759	19 inc 1U UniRack sa 24xE-2000 konektorima, G.652.D, APC, keramika, B/1	kom	20 %	158.055,36
732) 	000000711	R800954	19 inc 1U UniRack sa 36xE-2000 konektorima, G.652.D, APC, keramika, B/1	kom	20 %	211.191,84
733) 	000000712	R30398-24-APC	19 inc 1U UniRack sa 24xE-2000 konektorima, G.652.D, APC, keramika, C/1	kom	20 %	137.169,79

734)		0000000713	R310829	19 inc 1U UniRack sa 36xE-2000 konektorima, G.652.D, APC, keramika, C/1	kom	20 %	194.157,22
735)		0000000714	R302001	19 inc 2U UniRack sa 72xE-2000 konektorima, G.652.D, APC, keramika, C/1	kom	20 %	383.341,54
736)		0000000715	R30398-24-9	19 inc 1U UniRack sa 24xE-2000 konektorima, G.652.D, PC, keramika, C/2	kom	20 %	126.607,97
737)		0000000716	R800145	19 inc 1U UniRack sa 36xE-2000 konektorima, G.652.D, PC, keramika, C/2	kom	20 %	176.476,80
738)		0000000719	R804778	19 inc 1U UniRack sa 36xE-2000 konektorima, OM3, PC, keramika, Bm/3	kom	20 %	143.392,61
739)		0000000720	R804777	19 inc 1U UniRack sa 36xE-2000 konektorima, OM4, PC, keramika, Bm/3	kom	20 %	147.929,52

740)		000000717 R804784	19 inc 1U UniRack sa 24xFC konektorima, G.652.D, APC, keramika, C/1	kom	20 %	53.657,28
741)		000000718 R30318-24-9	19 inc 1U UniRack sa 24xFC konektorima, G.652.D, PC, keramika, C/2	kom	20 %	52.335,94
742)		000000721 R505558	19 inc 1U UniRack sa 24xLC-dupleks konektorima, G.652.D, APC, keramika, C/1	kom	20 %	168.733,25
743)		000000722 R308519	19 inc 2U UniRack sa 48xLC-dupleks konektorima, G.652.D, APC, keramika, C/1	kom	20 %	324.214,37
744)		000000725 R804731	19 inc 1U UniRack sa 24xLC-dupleks konektorima, OM4, PC, keramika, Bm/3	kom	20 %	98.222,88
745)		000000726 R804779	19 inc 1U UniRack sa 36xSC konektorima, G.652.D, APC, keramika, B/1	kom	20 %	120.712,51



746)		0000000727	R804780	19 inc 1U UniRack sa 36xSC konektorima, G.652.D, APC, keramika, C/1	kom	20 %	110.733,98
747)		0000000728	R802957	19 inc 2U UniRack sa 72xSC konektorima, G.652.D, APC, keramika, C/1	kom	20 %	237.636,58
748)		0000000729	R804781	19 inc 1U UniRack sa 36xSC konektorima, G.652.D, PC, keramika, C/2	kom	20 %	103.899,60
749)		0000000730	R804783	19 inc 1U UniRack sa 36xSC konektorima, OM3, PC, keramika, Bm/3	kom	20 %	76.018,94
750)		0000000731	R804782	19 inc 1U UniRack sa 36xSC konektorima, OM4, PC, keramika, Bm/3	kom	20 %	77.832,82
751)		0000000732	R804773	19 inc 1U UniRack sa 24xSC-dupleks konektorima, G.652.D, APC, keramika, C/1	kom	20 %	141.862,94

752)		000000733 R804774	19 inc 1U UniRack sa 24xSC-dupleks konektorima, G.652.D, PC, keramika, C/2	kom	20 %	130.807,10
753)		0000001345 R817499	19 inc 1U UniRack sa 6xSC-dupleks konektorima, G.652.D, PC, keramika, C/2	kom	20 %	54.972,67
754)		0000001346 R817500	19 inc 1U UniRack sa 12xSC-dupleks konektorima, G.652.D, PC, keramika, C/2	kom	20 %	82.604,83
755)		0000001292 R804690	19 inc 1U UniRack sa 12xSC-dupleks konektorima, OM3, PC, keramika, Bm/3	kom	20 %	56.898,14
756)		0000000734 R804630	19 inc 1U UniRack sa 24xSC-dupleks konektorima, OM3, PC, keramika, Bm/3	kom	20 %	94.740,96
757)		0000001293 R804691	19 inc 1U UniRack sa 12xSC-dupleks konektorima, OM4, PC, keramika, Bm/3	kom	20 %	59.877,12

758)		000000735 R804775	19 inc 1U UniRack sa 24xSC-dupleks konektorima, OM4, PC, keramika, Bm/3	kom	20 %	92.006,02
759)		000000736 R804786	19 inc 1U UniRack sa 24xST konektorima, OM3, PC, keramika, Bm/3	kom	20 %	42.693,70
760)		000000737 R804785	19 inc 1U UniRack sa 24xST konektorima, OM4, PC, keramika, Bm/3	kom	20 %	47.514,82

### 19 inc Unirack2

Proizvođač: Reichle & De-Massari

	Web šifra	Kat.oznaka	Naziv proizvoda	Jed.mere	PDV	Cena (din)
761)		0000001570 R816051	19 inc 1U UniRack2 sa 24xE-2000 konektorima, G.652.D, APC, keramika, C/1	kom	20 %	101.945,86
762)		0000001575 R816227	19 inc 1U UniRack2 sa 12xLC-dupleks konektorima, G.652.D, APC, keramika, C/1	kom	20 %	57.195,74

763)		0000001467 R819607	19 inc 1U UniRack2 sa 12xLC-dupleks konektorima, G.652.D, PC, keramika, C/2	kom	20 %	51.990,72
764)		0000001571 R819331	19 inc 1U UniRack2 sa 24xSC dupleks konektorima, G.652.D, PC, keramika, C/2	kom	20 %	94.627,87
765)		0000001574 R816243	19 inc 1U UniRack2 sa 6xSC dupleks konektorima, OM4, PC, keramika, Bm/3	kom	20 %	29.941,54
766)		0000001572 R816232	19 inc 1U UniRack2 sa 12xSC dupleks konektorima, OM4, PC, keramika, Bm/3	kom	20 %	46.624,99
767)		0000001573 R816041	19 inc 1U UniRack2 sa 24xSC dupleks konektorima, OM4, PC, keramika, Bm/3	kom	20 %	79.991,90

### 19 inc Fibereasy Rack





Proizvođač: Reichle & De-Massari







Web šifra	Kat.oznaka	Naziv proizvoda	Jed.mere	PDV	Cena (din)
-----------	------------	-----------------	----------	-----	------------

768)		0000001172	R306199	19 inc 1U FibereasyRack sa 24xE-2000 adaptera, SM, APC, keramika	kom	20 %	58.600,42
769)		0000001173	R316753	19 inc 1U FibereasyRack sa 12xLC-dupleks adaptera, SM, PC, keramika	kom	20 %	25.328,74
770)		0000001174	R805934	19 inc 1U FibereasyRack sa 12xLC-dupleks adaptera, OM3/OM4, PC, keramika	kom	20 %	27.013,15
771)		0000001177	R304360	19 inc 1U FibereasyRack sa 24xSC adaptera, SM, PC, keramika	kom	20 %	33.146,69
772)		0000001178	R30692-12	19 inc 1U FibereasyRack sa 12xSC-dupleks adapterima, SM, PC, keramika	kom	20 %	28.849,34
773)		0000001179	R804730	19 inc 1U FibereasyRack sa 12xSC-dupleks adapterima, MM, PC, keramika	kom	20 %	25.031,14

Fiber modul 7HP sa metalnom prednjom maskom

Proizvođač: Reichle & De-Massari

	Web šifra	Kat.oznaka	Naziv proizvoda	Jed.mere	PDV	Cena (din)
774)		000000738 R318552	Fiber modul 7HP, metal, splajs verzija sa 12xE-2000 G.652.D konektorima, APC, keramika, C/1	kom	20 %	54.547,10
775)		000000739 R318551	Fiber modul 7HP, metal, splajs verzija sa 12xE-2000 G.652.D konektorima, PC, keramika, C/2	kom	20 %	65.320,22
776)		000000740 R318817	Fiber modul 7HP, metal, splajs verzija sa 12xE-2000 OM1 konektorima, PC, keramika, Bm/3	kom	20 %	39.987,02
777)		000000741 R318818	Fiber modul 7HP, metal, splajs verzija sa 12xE-2000 OM2 konektorima, PC, keramika, Bm/3	kom	20 %	39.987,02
778)		000000742 R318819	Fiber modul 7HP, metal, splajs verzija sa 12xE-2000 OM3 konektorima, PC, keramika, Bm/3	kom	20 %	39.987,02

779)		000000743	R318956	Fiber modul 7HP, metal, splajs verzija sa 12xFC G.652.D konektorima, APC, keramika, C/1	kom	20 %	28.923,74
780)		000000744	R318947	Fiber modul 7HP, metal, splajs verzija sa 12xFC G.652.D konektorima, PC, keramika, C/2	kom	20 %	29.316,58
781)		000000745	R318554	Fiber modul 7HP, metal, splajs verzija sa 12xSC G.652.D konektorima, APC, keramika, C/1	kom	20 %	33.084,19
782)		000000746	R318553	Fiber modul 7HP, metal, splajs verzija sa 12xSC G.652.D konektorima, PC, keramika, C/2	kom	20 %	31.364,06
783)		000000747	R318824	Fiber modul 7HP, metal, splajs verzija sa 12xSC OM1 konektorima, PC, keramika, Bm/3	kom	20 %	28.411,87
784)		000000748	R318826	Fiber modul 7HP, metal, splajs verzija sa 12xSC OM2 konektorima, PC, keramika, Bm/3	kom	20 %	26.953,63

785)



000000749 R318825

Fiber modul 7HP, metal, splajs verzija sa 12xSC OM3 konektorima, PC, keramika, Bm/3 kom

20 %

28.411,87

786)



000000750 R318937

Fiber modul 7HP, metal, splajs verzija sa 12xST G.652.D konektorima, PC, PhBr, D/3 kom

20 %

27.005,71



787)

000000751 R318830

Fiber modul 7HP, metal, splajs verzija sa 12xST OM1 konektorima,  
PC, keramika, Bm/3

kom

20 %

25.447,78



788)

000000752 R318831

Fiber modul 7HP, metal, splajs verzija sa 12xST OM2 konektorima,  
PC, keramika, Bm/3

kom

20 %

24.150,24



789) 000000753 R318832 Fiber modul 7HP, metal, splajs verzija sa 12xST OM3 konektorima, PC, keramika, Bm/3 kom 20 % 25.447,78



790) 000000754 R318958 Fiber modul 7HP, metal, splajs verzija sa 6xE-2000-kompakt G.652.D konektorima, APC, keramika, C/1 kom 20 % 52.474,32



791) 000000755 R318949 Fiber modul 7HP, metal, splajs verzija sa 6xE-2000-kompakt G.652.D konektorima, PC, keramika, C/2 kom 20 % 49.897,10



792) 000000756 R318839 Fiber modul 7HP, metal, splajs verzija sa 6xE-2000-kompakt OM1 konektorima, PC, keramika, Bm/3 kom 20 % 36.671,76





793)		000000757	R318840	Fiber modul 7HP, metal, splajs verzija sa 6xE-2000-kompakt OM2 konektorima, PC, keramika, Bm/3	kom	20 %	36.671,76
794)		000000758	R318841	Fiber modul 7HP, metal, splajs verzija sa 6xE-2000-kompakt OM3 konektorima, PC, keramika, Bm/3	kom	20 %	36.671,76
795)		000000759	R318957	Fiber modul 7HP, metal, splajs verzija sa 6xLC-dupleks G.652.D konektorima, APC, keramika, C/1	kom	20 %	32.173,54
796)		000000760	R318948	Fiber modul 7HP, metal, splajs verzija sa 6xLC-dupleks G.652.D konektorima, PC, keramika, C/2	kom	20 %	29.569,54
797)		000000761	R513583	Fiber modul 7HP, metal, splajs verzija sa 6xLC-dupleks OM4 konektorima, PC, keramika, Bm/3	kom	20 %	25.906,08
798)		000000762	R318959	Fiber modul 7HP, metal, splajs verzija sa 6xSC-dupleks G.652.D konektorima, APC, keramika, C/1	kom	20 %	31.304,54







799)		000000763	R318950	Fiber modul 7HP, metal, splajs verzija sa 6xSC-dupleks G.652.D konektorima, PC, keramika, C/2	kom	20 %	30.545,66
800)		000000764	R318851	Fiber modul 7HP, metal, splajs verzija sa 6xSC-dupleks OM1 konektorima, PC, keramika, Bm/3	kom	20 %	24.224,64
801)		000000765	R318852	Fiber modul 7HP, metal, splajs verzija sa 6xSC-dupleks OM2 konektorima, PC, keramika, Bm/3	kom	20 %	23.348,21
802)		000000766	R318853	Fiber modul 7HP, metal, splajs verzija sa 6xSC-dupleks OM3 konektorima, PC, keramika, Bm/3	kom	20 %	24.224,64
803)		000000767	R318842	Fiber modul 7HP, metal, splajs verzija sa 6xSC-RJ OM1 konektorima, PC, keramika, Bm/3	kom	20 %	24.940,37
804)		000000768	R318843	Fiber modul 7HP, metal, splajs verzija sa 6xSC-RJ OM2 konektorima, PC, keramika, Bm/3	kom	20 %	24.940,37







805)		000000769 R318844	Fiber modul 7HP, metal, splajs verzija sa 6xSC-RJ OM3 konektorima, PC, keramika, Bm/3	kom	20 %	24.940,37
------	---	-------------------	---	-----	------	-----------

**Fiber modul 7HP sa plastičnom prednjom maskom**

**Proizvođač: Reichle & De-Massari**



		Web šifra	Kat.oznaka	Naziv proizvoda	Jed.mere	PDV	Cena (din)
806)		000000770	R318960	Fiber modul 7HP, plastika, splajs verzija sa 12xE-2000 G.652.D konektorima, APC, keramika, C/1	kom	20 %	51.946,08
807)		000000771	R318687	Fiber modul 7HP, plastika, splajs verzija sa 12xE-2000 G.652.D konektorima, PC, keramika, C/2	kom	20 %	62.926,03
808)		000000772	R318879	Fiber modul 7HP, plastika, splajs verzija sa 12xE-2000 OM1 konektorima, PC, keramika, Bm/3	kom	20 %	38.039,23
809)		000000773	R318880	Fiber modul 7HP, plastika, splajs verzija sa 12xE-2000 OM2 konektorima, PC, keramika, Bm/3	kom	20 %	38.039,23

810)		000000774	R318878	Fiber modul 7HP, plastika, splajs verzija sa 12xE-2000 OM3 konektorima, PC, keramika, Bm/3	kom	20 %	38.039,23
811)		000000775	R318962	Fiber modul 7HP, plastika, splajs verzija sa 12xFC G.652.D konektorima, APC, keramika, C/1	kom	20 %	27.560,74
812)		000000776	R318952	Fiber modul 7HP, plastika, splajs verzija sa 12xFC G.652.D konektorima, PC, keramika, C/2	kom	20 %	26.849,47
813)		000000777	R318961	Fiber modul 7HP, plastika, splajs verzija sa 12xSC G.652.D konektorima, APC, keramika, C/1	kom	20 %	30.480,19
814)		000000778	R318951	Fiber modul 7HP, plastika, splajs verzija sa 12xSC G.652.D konektorima, PC, keramika, C/2	kom	20 %	28.760,06
815)		000000779	R318884	Fiber modul 7HP, plastika, splajs verzija sa 12xSC OM1 konektorima, PC, keramika, Bm/3	kom	20 %	24.486,53

816)		000000780	R318885	Fiber modul 7HP, plastika, splajs verzija sa 12xSC OM2 konektorima, PC, keramika, Bm/3	kom	20 %	24.486,53
817)		000000781	R318886	Fiber modul 7HP, plastika, splajs verzija sa 12xSC OM3 konektorima, PC, keramika, Bm/3	kom	20 %	24.486,53
818)		000000782	R318943	Fiber modul 7HP, plastika, splajs verzija sa 12xST G.652.D konektorima, PC, PhBr, D/3	kom	20 %	25.057,92
819)		000000783	R318887	Fiber modul 7HP, plastika, splajs verzija sa 12xST OM1 konektorima, PC, keramika, Bm/3	kom	20 %	20.884,08
820)		000000784	R318888	Fiber modul 7HP, plastika, splajs verzija sa 12xST OM2 konektorima, PC, keramika, Bm/3	kom	20 %	21.680,16
821)		000000785	R318889	Fiber modul 7HP, plastika, splajs verzija sa 12xST OM3 konektorima, PC, keramika, Bm/3	kom	20 %	22.843,78



822)		000000786	R318964	Fiber modul 7HP, plastika, splajs verzija sa 6xE-2000-kompakt G.652.D konektorima, APC, keramika, C/1	kom	20 %	50.526,53
823)		000000787	R318954	Fiber modul 7HP, plastika, splajs verzija sa 6xE-2000-kompakt G.652.D konektorima, PC, keramika, C/2	kom	20 %	47.949,31
824)		000000788	R318892	Fiber modul 7HP, plastika, splajs verzija sa 6xE-2000-kompakt OM1 konektorima, PC, keramika, Bm/3	kom	20 %	34.723,97
825)		000000789	R318893	Fiber modul 7HP, plastika, splajs verzija sa 6xE-2000-kompakt OM2 konektorima, PC, keramika, Bm/3	kom	20 %	34.723,97
826)		000000790	R318894	Fiber modul 7HP, plastika, splajs verzija sa 6xE-2000-kompakt OM3 konektorima, PC, keramika, Bm/3	kom	20 %	34.723,97
827)		000000791	R318963	Fiber modul 7HP, plastika, splajs verzija sa 6xLC-dupleks G.652.D konektorima, APC, keramika, C/1	kom	20 %	29.569,54

828)		0000000792	R318953	Fiber modul 7HP, plastika, splajs verzija sa 6xLC-dupleks G.652.D konektorima, PC, keramika, C/2	kom	20 %	26.965,54
829)		0000000793	R318965	Fiber modul 7HP, plastika, splajs verzija sa 6xSC-dupleks G.652.D konektorima, APC, keramika, C/1	kom	20 %	28.703,52
830)		0000000794	R318955	Fiber modul 7HP, plastika, splajs verzija sa 6xSC-dupleks G.652.D konektorima, PC, keramika, C/2	kom	20 %	27.944,64
831)		0000000795	R318898	Fiber modul 7HP, plastika, splajs verzija sa 6xSC-dupleks OM1 konektorima, PC, keramika, Bm/3	kom	20 %	20.955,50
832)		0000000796	R318899	Fiber modul 7HP, plastika, splajs verzija sa 6xSC-dupleks OM2 konektorima, PC, keramika, Bm/3	kom	20 %	22.924,13
833)		0000000797	R318900	Fiber modul 7HP, plastika, splajs verzija sa 6xSC-dupleks OM3 konektorima, PC, keramika, Bm/3	kom	20 %	21.757,54

834)		000000798	R318895	Fiber modul 7HP, plastika, splajs verzija sa 6xSC-RJ OM1 konektorima, PC, keramika, Bm/3	kom	20 %	22.547,66
835)		000000799	R318896	Fiber modul 7HP, plastika, splajs verzija sa 6xSC-RJ OM2 konektorima, PC, keramika, Bm/3	kom	20 %	22.547,66
836)		000000800	R318897	Fiber modul 7HP, plastika, splajs verzija sa 6xSC-RJ OM3 konektorima, PC, keramika, Bm/3	kom	20 %	23.400,29

#### Fiber modul 5.6HP - Smartholes





Proizvođač: Reichle & De-Massari



		Web šifra	Kat.oznaka	Naziv proizvoda	Jed.mere	PDV	Cena (din)
837)		000000801	R319002	Fiber modul 5.6 plastika, splajs verzija sa 4xE-2000-kompakt G.652.D konektorima, APC, keramika, C/1	kom	20 %	35.293,87
838)		000000802	R319001	Fiber modul 5.6 plastika, splajs verzija sa 4xE-2000-kompakt G.652.D konektorima, PC, keramika, C/2	kom	20 %	33.575,23

839)		000000803	R318915	Fiber modul 5.6 plastika, splajs verzija sa 4xE-2000-kompakt OM1 konektorima, PC, keramika, Bm/3	kom	20 %	24.758,83
840)		000000804	R318916	Fiber modul 5.6 plastika, splajs verzija sa 4xE-2000-kompakt OM2 konektorima, PC, keramika, Bm/3	kom	20 %	24.758,83
841)		000000805	R318556	Fiber modul 5.6 plastika, splajs verzija sa 4xE-2000-kompakt OM3 konektorima, PC, keramika, Bm/3	kom	20 %	24.758,83
842)		000000806	R318917	Fiber modul 5.6 plastika, splajs verzija sa 4xSC-RJ OM1 konektorima, PC, keramika, Bm/3	kom	20 %	16.985,52
843)		000000807	R318918	Fiber modul 5.6 plastika, splajs verzija sa 4xSC-RJ OM2 konektorima, PC, keramika, Bm/3	kom	20 %	16.985,52
844)		000000808	R318557	Fiber modul 5.6 plastika, splajs verzija sa 4xSC-RJ OM3 konektorima, PC, keramika, Bm/3	kom	20 %	16.985,52

## Fiber modul 1U



**Proizvođač: Reichle & De-Massari**



	Web šifra	Kat.oznaka	Naziv proizvoda	Jed.mere	PDV	Cena (din)
845)		000000809 R319116	Fiber modul 1U, splajs verzija sa 4xE-2000-kompakt G.652.D konektorima, APC, keramika, C/1	kom	20 %	50.519,09
846)		000000810 R319115	Fiber modul 1U, splajs verzija sa 4xE-2000-kompakt G.652.D konektorima, PC, keramika, C/2	kom	20 %	45.479,23
847)		000000811 R319111	Fiber modul 1U, splajs verzija sa 4xE-2000-kompakt OM1 konektorima, PC, keramika, Bm/3	kom	20 %	24.565,39
848)		000000812 R319112	Fiber modul 1U, splajs verzija sa 4xE-2000-kompakt OM2 konektorima, PC, keramika, Bm/3	kom	20 %	28.495,20
849)		000000813 R319113	Fiber modul 1U, splajs verzija sa 4xE-2000-kompakt OM3 konektorima, PC, keramika, Bm/3	kom	20 %	28.495,20

850)		000000814 R319120	Fiber modul 1U, splajs verzija sa 4xSC-RJ OM1 konektorima, PC, keramika, Bm/3	kom	20 %	15.418,66
851)		000000815 R319121	Fiber modul 1U, splajs verzija sa 4xSC-RJ OM2 konektorima, PC, keramika, Bm/3	kom	20 %	17.884,27
852)		000000816 R319122	Fiber modul 1U, splajs verzija sa 4xSC-RJ OM3 konektorima, PC, keramika, Bm/3	kom	20 %	17.884,27

#### Fiber modul HD



Proizvođač: Reichle & De-Massari

	Web šifra	Kat.oznaka	Naziv proizvoda	Jed.mere	PDV	Cena (din)
853)		0000001294 R515078	Fiber modul HD, splajs verzija sa 12xE-2000 G.652.D konektorima, APC, keramika, C/1	kom	20 %	63.085,25
854)		0000001295 R515088	Fiber modul HD, splajs verzija sa 6xLC-Dupleks G.652.D konektorima, APC, keramika, C/1	kom	20 %	42.958,56

855)		0000001296	R808374	Fiber modul HD, splajs verzija sa 6xLC-Dupleks G.652.D konektorima, PC, keramika, C/2	kom	20 %	35.128,70
856)		0000001297	R515075	Fiber modul HD, splajs verzija sa 6xLC-Dupleks OM4 konektorima, PC, keramika, Bm/3	kom	20 %	26.409,02
857)		0000001298	R515077	Fiber modul HD, splajs verzija sa 6xSC-Dupleks G.652.D konektorima, APC, keramika, C/1	kom	20 %	36.140,54

### 19 inc prazni





**Proizvođač: Reichle & De-Massari**

		Web šifra	Kat.oznaka	Naziv proizvoda	Jed.mere	PDV	Cena (din)
858)		0000001135	R804258	19 inc, 1U modularni prespojni panel 36, za 3x7HP module, bez modula	kom	20 %	zvati
859)		0000001134	R319101	19 inc, 3U prespojni panel FO do 144 vlakana, bez modula, Global	kom	20 %	11.398,08

860)		0000001299	R512416	19 inc, 1U HD prespojni panel do 48 portova, bez modula, siv	kom	20 %	10.017,22
------	---	------------	---------	--	-----	------	-----------

**Oprema za optičke prespojne panele**

**Proizvođač: Reichle & De-Massari**



		Web šifra	Kat.oznaka	Naziv proizvoda	Jed.mere	PDV	Cena (din)
861)		0000001136	R510710	Poklopac za modularni prespojni panel 36, siv	kom	20 %	2.702,21
862)		0000001137	R306775	Poklopac za SpliceBox	kom	20 %	4.145,57
863)		0000001229	R304571	Slepo polje 3U umesto 7HP modula, siv	kom	20 %	1.580,26
864)		0000001167	R30004-20	Maska za prazno polje E-2000/SC/LC-dupleks	kom	20 %	66,96

865)		0000001168 R30843	Maska za prazno polje SC-dupleks	kom	20 %	zvati
------	---	-------------------	----------------------------------	-----	------	-------

## Splajs kasete

### Splajs kasete R30

Proizvođač: Reichle & De-Massari





	Web šifra	Kat.oznaka	Naziv proizvoda	Jed.mere	PDV	Cena (din)
866)		0000000660 R30279	Splajs kasete R30, bela	kom	20 %	437,47
867)		0000000661 R30278	Poklopac za splajs kasetu R30, beli	kom	20 %	339,26
868)		0000000662 R30393	Splajs kasete R30 osnovni set, bela	kom	20 %	976,13

869)		0000000663 R509121	Splajs kasete R30 osnovni set, crna	kom	20 %	1.261,82
870)		0000000664 R30394	Splajs kasete R30 dodatni set, bela	kom	20 %	693,41
871)		0000000665 R509122	Splajs kasete R30 dodatni set, crna	kom	20 %	976,13
872)		0000000666 R306774	Splajs kasete R30 za 19 inc 1U SpliceBox, bela	kom	20 %	2.693,28

### Splajs kasete R35

Proizvođač: Reichle & De-Massari



	Web šifra	Kat.oznaka	Naziv proizvoda	Jed.mere	PDV	Cena (din)
873)		0000000667 R318454	Splajs kasete R35, siva	kom	20 %	413,66

874)		0000000668 R318455	Poklopac za splajs kasetu R35, siv	kom	20 %	339,26
875)		0000000669 R318458	Splajs kasetu R35 osnovni set, siva	kom	20 %	919,58
876)		0000000670 R318004	Splajs kasetu R35 dodatni set, siva	kom	20 %	636,86
877)		0000000671 R318457	Splajs kasetu R35 za 19 inc 1U SpliceBox, siva	kom	20 %	2.693,28

### Splajs kasetu R40



Proizvođač: Reichle & De-Massari





	Web šifra	Kat.oznaka	Naziv proizvoda	Jed.mere	PDV	Cena (din)
878)		0000000672 R308447	Splajs kasetu R40, siva	kom	20 %	1.446,34





879)		0000000673	R308446	Poklopac za splajs kasetu R40, siv	kom	20 %	372,00
880)		0000000674	R308445	Splajs kasetu R40 osnovni set, siva	kom	20 %	1.699,30
881)		0000000675	R308444	Splajs kasetu R40 dodatni set, siva	kom	20 %	1.294,56

### Splajs kasetu SCM (Single Circuit Management)

Proizvođač: Reichle & De-Massari

		Web šifra	Kat.oznaka	Naziv proizvoda	Jed.mere	PDV	Cena (din)
882)		0000000676	R508434	Splajs kasetu SCM, tip SC za 6 splajseva	kom	20 %	589,25
883)		0000000677	R508440	Splajs kasetu SCM, tip SC za 6 splajseva, pakovanje 12 kom.	kom	20 %	6.526,37

884)		000000678	R804270	Splajs kaseta SCM, tip SC za 12 splajseva, termoskupljajući splice protect	kom	20 %	791,62
885)		000000679	R804272	Splajs kaseta SCM, tip SC za 12 splajseva, termoskupljajući splice protect, pakovanje 12 kom.	kom	20 %	9.029,18
886)		000000680	R804271	Splajs kaseta SCM, tip SC za 12 splajseva, ANT splice protect	kom	20 %	764,83
887)		000000681	R804273	Splajs kaseta SCM, tip SC za 12 splajseva, ANT splice protect, pakovanje 12 kom.	kom	20 %	9.029,18
888)		000000682	R508436	Splajs kaseta SCM, tip SE za 24 splajseva, termoskupljajući splice protect	kom	20 %	958,27
889)		000000683	R508441	Splajs kaseta SCM, tip SE za 24 splajseva, termoskupljajući splice protect, pakovanje 6 kom.	kom	20 %	5.380,61

890)		0000000684	R508438	Splajs kaseta SCM, tip SE za 24 splajseva, ANT splice protect	kom	20 %	958,27
891)		0000000685	R508442	Splajs kaseta SCM, tip SE za 24 splajseva, ANT splice protect, pakovanje 6 kom.	kom	20 %	5.380,61
892)		0000000686	R508439	Splajs kaseta SCM, tip SE	kom	20 %	1.211,23
893)		0000000687	R509162	Poklopac za splajs kasetu SCM	kom	20 %	1.404,67

#### Oprema za splajs kasete

Proizvođač: Reichle & De-Massari

	Web šifra	Kat.oznaka	Naziv proizvoda	Jed.mere	PDV	Cena (din)	
894)		0000000688	R30255	Splajs holder za R30/R40 za ANT splice protect (12)	kom	20 %	127,97







895)		0000000689	R30039-06	Splajs holder za R30/R40 za termoskupljajući splice protect (6)	kom	20 %	404,74
896)		0000000690	R320246	Splajs holder za R30/R40 za termoskupljajući splice protect (12)	kom	20 %	142,85
897)		0000000691	R30042	Splajs holder za R30/R40 za 3M fiberlok splice protect (6)	kom	20 %	zvati
898)		0000000692	R30086	Splajs protect ANT	kom	20 %	205,34
899)		0000000693	R30087	Splajs protect termoskupljajući 60 mm	kom	20 %	190,46
900)		0000000694	R319212	Splajs protect termoskupljajući 45 mm	kom	20 %	148,80







901)		0000000695	R30087-35	Splajs protect termoskupljajući 35 mm	kom	20 %	172,61
902)		0000000696	R30089	Splajs konektor 3M fiberlok	kom	20 %	3.867,31
903)		0000000697	R30204	Češalj za smanjenje naprezanja optičkih vlakana, za 6 vlakana &#216; 1.9-2.1 mm, zelen	kom	20 %	229,15
904)		0000000698	R320141	Češalj za smanjenje naprezanja optičkih vlakana, za 12 vlakana &#216; 0.9 mm, crven	kom	20 %	136,90
905)		0000000699	R308456	Češalj za smanjenje naprezanja optičkih vlakana, za 24 vlakana &#216; 0.9 - 1.1 mm, crven	kom	20 %	205,34

## Optički adapteri

E-2000

Proizvođač: Reichle & De-Massari

		Web šifra	Kat.oznaka	Naziv proizvoda	Jed.mere	PDV	Cena (din)
906)		0000000285	R504801	Adapter E-2000 APC, zelen/zelen, keramika, SM, B	kom	20 %	2.202,24
907)		0000000286	R504541	Adapter E-2000 APC, zelen/zelen, keramika, SM, C	kom	20 %	1.621,92
908)		0000000287	R504514	Adapter E-2000 PC, plav/plav, keramika, SM, B	kom	20 %	1.904,64
909)		0000000288	R504511	Adapter E-2000 PC, plav/plav, keramika, SM, C	kom	20 %	1.803,46
910)		0000000289	R504505	Adapter E-2000 PC, plav/plav, PhBr, SM, D	kom	20 %	1.418,06
911)		0000000291	R505516	Adapter E-2000 PC, bež/oranž, keramika, MM, M	kom	20 %	1.318,37



912)		0000000292	R504483	Adapter E-2000 PC, bež/oranž, PhBr, MM, N	kom	20 %	1.284,14
913)		0000000294	R504839	Adapter E-2000 APC, zelen/zelen, keramika, SM, B, bez oboda	kom	20 %	1.874,88
914)		0000000293	R504562	Adapter E-2000 APC, zelen/zelen, keramika, SM, C, bez oboda	kom	20 %	1.596,62
915)		0000000295	R504533	Adapter E-2000 PC, plav/plav, keramika, SM, B, bez oboda	kom	20 %	1.874,88
916)		0000000296	R504512	Adapter E-2000 PC, plav/plav, keramika, SM, C, bez oboda	kom	20 %	1.717,15
917)		0000000297	R505527	Adapter E-2000 PC, plav/plav, PhBr, SM, D, bez oboda	kom	20 %	1.575,79

918)		0000000298	R504473	Adapter E-2000 PC, bež/oranž, keramika, MM, M, bez oboda	kom	20 %	1.395,74
------	---	------------	---------	--	-----	------	----------



919)		0000000299	R504493	Adapter E-2000 PC, bež/oranž, PhBr, MM, N, bez oboda	kom	20 %	1.449,31
------	---	------------	---------	--	-----	------	----------

### LC-dupleks

**Proizvođač: Reichle & De-Massari**



		Web šifra	Kat.oznaka	Naziv proizvoda	Jed.mere	PDV	Cena (din)
920)		0000000303	R501255	Adapter LC-dupleks APC, zelen/zelen-zelen, keramika, SM, C	kom	20 %	882,38
921)		0000000304	R501209	Adapter LC-dupleks PC, plav/plav-plav, keramika, SM, C	kom	20 %	669,60
922)		0000000305	R500270	Adapter LC-dupleks PC, plav/plav-plav, PhBr, SM, D	kom	20 %	614,54





923)		0000000307	R500135	Adapter LC-dupleks PC, bež/bež-bež, keramika, MM, M	kom	20 %	629,42
924)		0000000308	R501246	Adapter LC-dupleks PC, bež/bež-bež, PhBr, MM, N	kom	20 %	502,94
925)		0000001166	R500078	Adapter LC-dupleks PC, bež/bež-bež, PhBr, MM, N	kom	20 %	480,62
926)		0000000309	R501572	Adapter LC-dupleks APC, zelen/zelen-zelen, keramika, SM, C, bez oboda	kom	20 %	781,20
927)		0000000310	R501469	Adapter LC-dupleks PC, plav/plav-plav, keramika, SM, C, bez oboda	kom	20 %	669,60
928)		0000000311	R500202	Adapter LC-dupleks PC, plav/plav-plav, PhBr, SM, D, bez oboda	kom	20 %	614,54

929)		0000000312	R500145	Adapter LC-dupleks PC, bež/bež-bež, keramika, MM, M, bez oboda	kom	20 %	629,42
930)		0000000313	R501487	Adapter LC-dupleks PC, bež/bež-bež, PhBr, MM, N, bez oboda	kom	20 %	502,94

**SC, SC dupleks, SC-RJ**







**Proizvođač: Reichle & De-Massari**

		<b>Web šifra</b>	<b>Kat.oznaka</b>	<b>Naziv proizvoda</b>	<b>Jed.mere</b>	<b>PDV</b>	<b>Cena (din)</b>
931)		0000000314	R503781	Adapter SC APC, zelen, keramika, SM, B	kom	20 %	334,80
932)		0000000315	R503773	Adapter SC APC, zelen, keramika, SM, C	kom	20 %	340,75
933)		0000000316	R503768	Adapter SC PC, plav, keramika, SM, B	kom	20 %	334,80

934)		0000000317	R503761	Adapter SC PC, plav, keramika, SM, C	kom	20 %	293,14
935)		0000000319	R503688	Adapter SC PC, bež, keramika, MM, M	kom	20 %	245,52
936)		0000000321	R503783	Adapter SC APC, zelen, keramika, SM, B, bez oboda	kom	20 %	334,80
937)		0000000322	R503776	Adapter SC APC, zelen, keramika, SM, C, bez oboda	kom	20 %	302,06
938)		0000000323	R503769	Adapter SC PC, plav, keramika, SM, B, bez oboda	kom	20 %	334,80
939)		0000000324	R503762	Adapter SC PC, plav, keramika, SM, C, bez oboda	kom	20 %	315,46

940)		0000000326	R503689	Adapter SC PC, bež, keramika, MM, M, bez oboda	kom	20 %	276,77
941)		0000000329	R804260	Adapter SC-dupleks APC, zelen, keramika, SM, C	kom	20 %	1.142,78
942)		0000000330	R30805	Adapter SC-dupleks PC, plav, keramika, SM, C	kom	20 %	1.142,78
943)		0000000332	R317064	Adapter SC-dupleks PC, bež, keramika, MM, M	kom	20 %	788,64
944)		0000000334	R318279	Adapter SC-RJ APC, zelen, keramika, SM, B, Snap-in	kom	20 %	1.443,36
945)		0000000335	R318278	Adapter SC-RJ APC, zelen, keramika, SM, C, Snap-in	kom	20 %	1.243,97

946)		0000000336	R318276	Adapter SC-RJ PC, plav, keramika, SM, C, Snap-in	kom	20 %	1.243,97
947)		0000000337	R318275	Adapter SC-RJ PC, plav, PhBr, SM, D, Snap-in	kom	20 %	781,20
948)		0000000338	R318274	Adapter SC-RJ PC, bež, keramika, MM, M, Snap-in	kom	20 %	zvati
949)		0000000339	R318273	Adapter SC-RJ PC, bež, PhBr, MM, N, Snap-in	kom	20 %	907,68
950)		0000000340	R318272	Adapter SC-RJ APC, zelen, keramika, SM, B, support plate	kom	20 %	1.319,86
951)		0000000341	R318271	Adapter SC-RJ APC, zelen, keramika, SM, C, support plate	kom	20 %	1.243,97

952)		0000000342	R318270	Adapter SC-RJ PC, plav, keramika, SM, C, support plate	kom	20 %	1.243,97
953)		0000000343	R318269	Adapter SC-RJ PC, plav, PhBr, SM, D, support plate	kom	20 %	1.133,86
954)		0000000344	R318268	Adapter SC-RJ PC, bež, keramika, MM, M, support plate	kom	20 %	zvati
955)		0000000345	R318266	Adapter SC-RJ PC, bež, PhBr, MM, N, support plate	kom	20 %	654,72
956)		0000000346	R510759	Adapter SC-RJ APC, zelen, keramika, SM, C, bez oboda	kom	20 %	1.154,69
957)		0000000347	R510758	Adapter SC-RJ PC, plav, keramika, SM, C, bez oboda	kom	20 %	1.217,18

958)		0000000348	R311496	Adapter IP67 SC-RJ PC, crn, keramika, SM, C	kom	20 %	1.520,74
------	---	------------	---------	---	-----	------	----------

959)		0000000349	R309641	Adapter IP67 SC-RJ PC, crn, PhBr, MM, N	kom	20 %	864,53
------	---	------------	---------	---	-----	------	--------

ST

Proizvođač: Reichle & De-Massari

	Web šifra	Kat.oznaka	Naziv proizvoda	Jed.mere	PDV	Cena (din)	
960)		0000000350	R30802	Adapter ST PC, keramika, SM/MM	kom	20 %	523,78

Univerzalni

Proizvođač: Reichle & De-Massari

	Web šifra	Kat.oznaka	Naziv proizvoda	Jed.mere	PDV	Cena (din)	
961)		0000000353	R318742	Univerzalni adapter, prazan, SC/E-2000/LC-dupleks	kom	20 %	339,26



962)		0000000354	R318744	Univerzalni adapter, prazan, FC	kom	20 %	339,26
------	---	------------	---------	---------------------------------	-----	------	--------

963)		0000000355	R318743	Univerzalni adapter, prazan, ST	kom	20 %	339,26
------	---	------------	---------	---------------------------------	-----	------	--------

### Optički konektori - pigtails

#### E-2000

Proizvođač: Reichle & De-Massari







	Web šifra	Kat.oznaka	Naziv proizvoda	Jed.mere	PDV	Cena (din)	
964)		0000000253	R802918	Pigtail E-2000 APC, zeleni/beli, G.652.D (žuta), B/1, 2.5 m	kom	20 %	2.071,30
965)		0000000254	R30967	Pigtail E-2000 APC, zeleni/beli, G.652.D (žuta), C/1, 2.5 m	kom	20 %	1.595,14

966)		0000000247 R30964	Pigtail E-2000 PC, plav/plav, G.652.D (žuta), C/2, 2.5 m	kom	20 %	2.083,20
967)		0000000248 R802917	Pigtail E-2000 PC, bež/plav, OM1 (plava), Bm/3, 2.5 m	kom	20 %	1.071,36
968)		0000000249 R802916	Pigtail E-2000 PC, bež/oranž, OM2 (oranž), Bm/3, 2.5 m	kom	20 %	1.071,36
969)		0000000250 R802915	Pigtail E-2000 PC, bež/tirkiz, OM3 (tirkiz), Bm/3, 2.5 m	kom	20 %	1.523,71
970)		0000000251 R802914	Pigtail E-2000 PC, bež/tirkiz, OM4 (tirkiz) Bm/3, 2.5 m	kom	20 %	1.538,59





LC

Proizvođač: Reichle & De-Massari

Web šifra	Kat.oznaka	Naziv proizvoda	Jed.mere	PDV	Cena (din)
-----------	------------	-----------------	----------	-----	------------

971)		0000000252	R803500	Pigtail LC APC, zeleni, G.652.D (žuta), A/1, 2.5 m	kom	20 %	2.723,04
972)		0000000255	R803512	Pigtail LC APC, zeleni, G.652.D (žuta), B/1, 2.5 m	kom	20 %	2.178,43
973)		0000000256	R803524	Pigtail LC APC, zeleni, G.652.D (žuta), C/1, 2.5 m	kom	20 %	1.833,22
974)		0000000257	R803536	Pigtail LC APC, zeleni, G.657 (žuta), A/1, 2.5 m	kom	20 %	2.004,34
975)		0000000258	R803537	Pigtail LC APC, zeleni, G.657 (žuta), B/1, 2.5 m	kom	20 %	2.083,20
976)		0000000259	R803538	Pigtail LC APC, zeleni, G.657 (žuta), C/1, 2.5 m	kom	20 %	1.851,07



977)		0000000260	R803542	Pigtail LC PC, plav, G.652.D (žuta), A/2, 2.5 m	kom	20 %	2.592,10
978)		0000000261	R803543	Pigtail LC PC, plav, G.652.D (žuta), B/2, 2.5 m	kom	20 %	1.868,93
979)		0000000262	R803544	Pigtail LC PC, plav, G.652.D (žuta), C/2, 2.5 m	kom	20 %	1.624,90
980)		0000000263	R803545	Pigtail LC PC, plav, G.652.D (žuta), D/2, 2.5 m	kom	20 %	1.083,26
981)		0000000264	R803539	Pigtail LC PC, plav, G.657 (žuta), A/2, 2.5 m	kom	20 %	2.609,95
982)		0000000265	R803540	Pigtail LC PC, plav, G.657 (žuta), B/2, 2.5 m	kom	20 %	1.987,97



983)		0000000266	R803541	Pigtail LC PC, plav, G.657 (žuta), C/2, 2.5 m	kom	20 %	1.642,75
984)		0000000267	R803546	Pigtail LC PC, bež, OM1 (plava), Bm/3, 2.5 m	kom	20 %	863,04
985)		0000000268	R803547	Pigtail LC PC, bež, OM2 (oranž), Bm/3, 2.5 m	kom	20 %	863,04
986)		0000000269	R803548	Pigtail LC PC, bež, OM3 (tirkiz), Bm/3, 2.5 m	kom	20 %	901,73
987)		0000000270	R803549	Pigtail LC PC, bež, OM4 (tirkiz), Bm/3, 2.5 m	kom	20 %	916,61

SC

Proizvođač: Reichle & De-Massari



Web šifra	Kat.oznaka	Naziv proizvoda	Jed.mere	PDV	Cena (din)
-----------	------------	-----------------	----------	-----	------------



988)		0000000271	R312361	Pigtail SC APC, zeleni, G.652.D (žuta), B/1, 2.5 m	kom	20 %	2.178,43
989)		0000000272	R31015	Pigtail SC APC, zeleni, G.652.D (žuta), C/1, 2.5 m	kom	20 %	1.833,22
990)		0000000273	R31014	Pigtail SC PC, plav, G.652.D (žuta), C/2, 2.5 m	kom	20 %	1.624,90
991)		0000000274	R301462	Pigtail SC PC, bež, OM1 (plava), Bm/3, 2.5 m	kom	20 %	863,04
992)		0000000275	R301461	Pigtail SC PC, bež, OM2 (oranž), Bm/3, 2.5 m	kom	20 %	988,03
993)		0000001439	R812514	Pigtail SC PC, bež, OM3 (tirkiz), Am/2, 2.5 m	kom	20 %	1.002,91

994)		0000000276 R307388	Pigtail SC PC, bež, OM3 (tirkiz), Bm/3, 2.5 m	kom	20 %	901,73
995)		0000001440 R812515	Pigtail SC PC, bež, OM4 (tirkiz), Am/2, 2.5 m	kom	20 %	1.002,91
996)		0000000277 R802912	Pigtail SC PC, bež, OM4 (tirkiz), Bm/3, 2.5 m	kom	20 %	916,61

ST



Proizvođač: Reichle & De-Massari

	Web šifra	Kat.oznaka	Naziv proizvoda	Jed.mere	PDV	Cena (din)
997)		0000000278 R313152	Pigtail ST PC, G.652.D (žuta), D/3, 2.5 m	kom	20 %	1.017,79
998)		0000000279 R307300	Pigtail ST PC, OM1 (plava), Bm/3, 2.5 m	kom	20 %	863,04

999)		0000000280	R307299	Pigtail ST PC, OM2 (oranž), Bm/3, 2.5 m	kom	20 %	863,04
1000)		0000000281	R307387	Pigtail ST PC, OM3 (tirkiz), Bm/3, 2.5 m	kom	20 %	854,11
1001)		0000000282	R802913	Pigtail ST PC, OM4 (tirkiz), Bm/3, 2.5 m	kom	20 %	868,99

### FC



**Proizvođač: Reichle & De-Massari**

		Web šifra	Kat.oznaka	Naziv proizvoda	Jed.mere	PDV	Cena (din)
1002)		0000000283	R301456	Pigtail FC APC, G.652.D (žuta), C/1, 2.5 m	kom	20 %	1.148,74
1003)		0000000284	R301451	Pigtail FC PC, G.652.D (žuta), C/2, 2.5 m	kom	20 %	1.071,36

## Utičnice za optičke module

### Global

Proizvođač: Reichle & De-Massari

	Web šifra	Kat.oznaka	Naziv proizvoda	Jed.mere	PDV	Cena (din)
1004)		0000001141 R316072	Uzidna utičnica 88x88 za 2xSC-Dupleks modula, bela, Global	kom	20 %	889,82
1005)		0000001142 R316073	Nazidna utičnica 80x80 za 2xSC-Dupleks modula, bela, Global	kom	20 %	1.059,46
1006)		0000001143 R316074	Kanalska utičnica 80x86 za 2xSC-Dupleks modula, bela, Global	kom	20 %	877,92

### Nazidne utičnice

Proizvođač: Reichle & De-Massari

	Web šifra	Kat.oznaka	Naziv proizvoda	Jed.mere	PDV	Cena (din)
--	-----------	------------	-----------------	----------	-----	------------

1007)		0000001144	R515897	Nazidna utičnica sa 1xE-2000 APC adapterom, zelen, 1-pigtail G.657.A, keramika, C/1	kom	20 %	4.586,02
1008)		0000001146	R515898	Nazidna utičnica sa 2xE-2000 APC adapterima, zelen, 2-pigtail G.657.A, keramika, C/1	kom	20 %	4.865,76
1009)		0000001147	R515036	Nazidna utičnica sa 1xLC-dupleks adapterom APC, zelen, keramika, C	kom	20 %	2.740,90
1010)		0000001148	R515035	Nazidna utičnica sa 1xLC-dupleks APC adapterom, zelen, 1-pigtail G.657.A, keramika, C/1	kom	20 %	3.949,15
1011)		0000001149	R515034	Nazidna utičnica sa 1xLC-dupleks APC adapteroma, zelen, 2-pigtail G.657.A, keramika, C/1	kom	20 %	4.937,18
1012)		0000001150	R515037	Nazidna utičnica sa 2xLC-dupleks adapterima APC, zelen, keramika, C	kom	20 %	3.289,97

1013)		0000001151	R515038	Nazidna utičnica sa 2xLC-dupleks APC adapterima, zelen, 4-pigtail G.657.A, keramika, C/1	kom	20 %	7.901,28
1014)		0000001152	R515039	Nazidna utičnica sa 1xSC APC adapterom, zelen, 1-pigtail G.657.A, keramika, C/1	kom	20 %	4.163,42
1015)		0000001155	R509496	Nazidna hibridna utičnica sa 1xLC-dupleks APC adapterom, zelen, keramika	kom	20 %	4.288,42
1016)		0000001154	R505976	Nazidna hibridna utičnica sa 2xLC-dupleks APC adapterima, zelen, keramika	kom	20 %	5.559,17
1017)		0000001158	R509497	Nazidna hibridna utičnica sa 2xLC-dupleks APC adapterima, zelen, keramika	kom	20 %	5.898,43
1018)		0000001156	R509492	Nazidna hibridna utičnica sa 1xLC-dupleks APC adapterom, zelen, 1-pigtail G.657.A, keramika, C	kom	20 %	6.404,35

1019)		0000001157	R509493	Nazidna hibridna utičnica sa 1xLC-dupleks APC adapterom, zelen, 2-pigtail G.657.A, keramika, C	kom	20 %	8.520,29
1020)		0000001159	R509494	Nazidna hibridna utičnica sa 2xLC-dupleks APC adapterima, zelen, 2-pigtail G.657.A, keramika, C	kom	20 %	10.130,30
1021)		0000001160	R509495	Nazidna hibridna utičnica sa 2xLC-dupleks APC adapterima, zelen, 4-pigtail G.657.A, keramika, C	kom	20 %	14.362,18
1022)		0000001161	R510874	Nazidna hibridna utičnica sa 1xSC APC adapterom, zelen, keramika	kom	20 %	2.990,88
1023)		0000001162	R510875	Nazidna hibridna utičnica sa 1xSC-RJ APC adapterom, zelen, keramika	kom	20 %	3.428,35
1024)		0000001163	R315799	Nazidna utičnica za 2xSC-dupleks / 4xSC / 4xLC-dupleks / 4xST adaptore	kom	20 %	3.321,22

## Kanalske utičnice



**Proizvođač: Reichle & De-Massari**

	Web šifra	Kat.oznaka	Naziv proizvoda	Jed.mere	PDV	Cena (din)
1025) 	0000001164	R315798	Kanalska utičnica za 2xSC-dupleks / 4xSC / 4xLC-dupleks / 4xST adaptere	kom	20 %	3.211,10

## Optički prespojni kablovi

**E-2000**

**Proizvođač: Reichle & De-Massari**

	Web šifra	Kat.oznaka	Naziv proizvoda	Jed.mere	PDV	Cena (din)
1026) 	0000000817	R30989	Prespojni kabl E-2000 APC - E-2000 APC, zelen/beo, G.652.D , C/1, &#216; 2.0 mm, 2 m	kom	20 %	5.648,45
1027) 	0000000818	R30990	Prespojni kabl E-2000 APC - E-2000 APC, zelen/beo, G.652.D , C/1, &#216; 2.0 mm, 3 m	kom	20 %	4.578,58

1028)		0000000819	R30979	Prespojni kabl E-2000 APC - E-2000 APC, zelen/zelen, G.652.D , C/1, &#216; 3.0 mm, 2 m	kom	20 %	3.420,91
1029)		0000000820	R30980	Prespojni kabl E-2000 APC - E-2000 APC, zelen/zelen, G.652.D , C/1, &#216; 3.0 mm, 3 m	kom	20 %	3.481,92
1030)		0000000821	R30982	Prespojni kabl E-2000 APC - E-2000 APC, zelen/zelen, G.652.D , C/1, &#216; 3.0 mm, 5 m	kom	20 %	3.461,09
1031)		0000000822	R319986	Prespojni kabl E-2000 APC - E-2000 APC, zelen/beo, G.652.D , A/1, &#216; 3.0 mm, 2 m	kom	20 %	8.506,90
1032)		0000000823	R319987	Prespojni kabl E-2000 APC - E-2000 APC, zelen/beo, G.652.D , A/1, &#216; 3.0 mm, 3 m	kom	20 %	8.564,93
1033)		0000000824	R319988	Prespojni kabl E-2000 APC - E-2000 APC, zelen/beo, G.652.D , A/1, &#216; 3.0 mm, 5 m	kom	20 %	8.679,50





1034)		0000000825	R311328	Prespojni kabl E-2000 APC - E-2000 APC, zelen/beo, G.652.D , B/1, &#216; 3.0 mm, 2 m	kom	20 %	4.650,00
1035)		0000000826	R312287	Prespojni kabl E-2000 APC - E-2000 APC, zelen/beo, G.652.D , B/1, &#216; 3.0 mm, 3 m	kom	20 %	4.708,03
1036)		0000000827	R310770	Prespojni kabl E-2000 APC - E-2000 APC, zelen/beo, G.652.D , B/1, &#216; 3.0 mm, 5 m	kom	20 %	4.821,12
1037)		0000000828	R30983	Prespojni kabl E-2000 APC - E-2000 APC, zelen/beo, G.652.D , C/1, &#216; 3.0 mm, 1 m	kom	20 %	3.231,94
1038)		0000000829	R30984	Prespojni kabl E-2000 APC - E-2000 APC, zelen/beo, G.652.D , C/1, &#216; 3.0 mm, 2 m	kom	20 %	3.420,91
1039)		0000000830	R30985	Prespojni kabl E-2000 APC - E-2000 APC, zelen/beo, G.652.D , C/1, &#216; 3.0 mm, 3 m	kom	20 %	3.346,51

1040)		0000000831	R30987	Prespojni kabl E-2000 APC - E-2000 APC, zelen/beo, G.652.D , C/1, &#216; 3.0 mm, 5 m	kom	20 %	3.461,09
1041)		0000000832	R802900	Prespojni kabl E-2000 APC - E-2000 APC, zelen/beo, G.657, C/1, &#216; 3.0 mm, 2 m	kom	20 %	3.420,91
1042)		0000000833	R802903	Prespojni kabl E-2000 APC - E-2000 APC, zelen/beo, G.657, C/1, &#216; 3.0 mm, 3 m	kom	20 %	3.346,51
1043)		0000000834	R802905	Prespojni kabl E-2000 APC - E-2000 APC, zelen/beo, G.657, C/1, &#216; 3.0 mm, 5 m	kom	20 %	3.461,09
1044)		0000000835	R30969	Prespojni kabl E-2000 PC - E-2000 PC, plav/plav, G.652.D , C/2, &#216; 3.0 mm, 2 m	kom	20 %	3.063,79
1045)		0000000836	R30970	Prespojni kabl E-2000 PC - E-2000 PC, plav/plav, G.652.D , C/2, &#216; 3.0 mm, 3 m	kom	20 %	3.248,30

1046)		0000000837 R30972	Prespojni kabl E-2000 PC - E-2000 PC, plav/plav, G.652.D , C/2, &#216; 3.0 mm, 5 m	kom	20 %	3.367,34
-------	---	-------------------	--	-----	------	----------

### E-2000 kompakt

Proizvođač: Reichle & De-Massari

		Web šifra	Kat.oznaka	Naziv proizvoda	Jed.mere	PDV	Cena (din)
1047)		0000000838	R303358	Prespojni kabl E-2000-kompakt APC - E-2000-kompakt APC, zelen/zelen, G.652.D, C/1, F8 2.7x5.5 mm, 2 m	kom	20 %	6.844,80
1048)		0000000839	R303359	Prespojni kabl E-2000-kompakt APC - E-2000-kompakt APC, zelen/zelen, G.652.D, C/1, F8 2.7x5.5 mm, 3 m	kom	20 %	6.693,02
1049)		0000000840	R303361	Prespojni kabl E-2000-kompakt APC - E-2000-kompakt APC, zelen/zelen, G.652.D, C/1, F8 2.7x5.5 mm, 5 m	kom	20 %	7.201,92
1050)		0000000841	R303363	Prespojni kabl E-2000-kompakt APC - E-2000-kompakt APC, zelen/beo, G.652.D, C/1, F8 2.7x5.5 mm, 2 m	kom	20 %	6.579,94

1051)		0000000842	R303364	Prespojni kabl E-2000-kompakt APC - E-2000-kompakt APC, zelen/beo, G.652.D, C/1, F8 2.7x5.5 mm, 3 m	kom	20 %	6.693,02
1052)		0000000843	R303366	Prespojni kabl E-2000-kompakt APC - E-2000-kompakt APC, zelen/beo, G.652.D, C/1, F8 2.7x5.5 mm, 5 m	kom	20 %	6.922,18
1053)		0000000844	R303348	Prespojni kabl E-2000-kompakt PC - E-2000-kompakt PC, plav/plav, G.652.D, C/2, F8 2.7x5.5 mm, 2 m	kom	20 %	6.124,61
1054)		0000000845	R303349	Prespojni kabl E-2000-kompakt PC - E-2000-kompakt PC, plav/plav, G.652.D, C/2, F8 2.7x5.5 mm, 3 m	kom	20 %	6.240,67
1055)		0000000846	R303351	Prespojni kabl E-2000-kompakt PC - E-2000-kompakt PC, plav/plav, G.652.D, C/2, F8 2.7x5.5 mm, 5 m	kom	20 %	6.468,34
1056)		0000000847	R317466	Prespojni kabl E-2000-kompakt PC - E-2000-kompakt PC, plav/plav, G.652.D, D/3, F8 2.7x5.5 mm, 2 m	kom	20 %	4.763,09





1057)		0000000848	R317489	Prespojni kabl E-2000-kompakt PC - E-2000-kompakt PC, plav/plav, G.652.D, D/3, F8 2.7x5.5 mm, 3 m	kom	20 %	4.879,15
1058)		0000000849	R317490	Prespojni kabl E-2000-kompakt PC - E-2000-kompakt PC, plav/plav, G.652.D, D/3, F8 2.7x5.5 mm, 5 m	kom	20 %	5.106,82
1059)		0000000851	R323123	Prespojni kabl E-2000-kompakt PC - E-2000-kompakt PC, bež/plav, OM1, M/4, F8 2.7x5.5 mm, 1 m	kom	20 %	4.612,80
1060)		0000000850	R323129	Prespojni kabl E-2000-kompakt PC - E-2000-kompakt PC, bež/plav, OM1, M/4, F8 2.7x5.5 mm, 2 m	kom	20 %	5.141,04
1061)		0000000852	R323130	Prespojni kabl E-2000-kompakt PC - E-2000-kompakt PC, bež/plav, OM1, M/4, F8 2.7x5.5 mm, 3 m	kom	20 %	5.669,28
1062)		0000000853	R323131	Prespojni kabl E-2000-kompakt PC - E-2000-kompakt PC, bež/plav, OM1, M/4, F8 2.7x5.5 mm, 5 m	kom	20 %	6.727,25



1063)		0000000854	R323124	Prespojni kabl E-2000-kompakt PC - E-2000-kompakt PC, bež/oranž, OM2, M/4, F8 2.7x5.5 mm, 1 m	kom	20 %	4.347,94
1064)		0000000855	R323132	Prespojni kabl E-2000-kompakt PC - E-2000-kompakt PC, bež/oranž, OM2, M/4, F8 2.7x5.5 mm, 2 m	kom	20 %	4.614,29
1065)		0000000856	R323133	Prespojni kabl E-2000-kompakt PC - E-2000-kompakt PC, bež/oranž, OM2, M/4, F8 2.7x5.5 mm, 3 m	kom	20 %	4.879,15
1066)		0000000857	R323134	Prespojni kabl E-2000-kompakt PC - E-2000-kompakt PC, bež/oranž, OM2, M/4, F8 2.7x5.5 mm, 5 m	kom	20 %	5.408,88
1067)		0000000858	R323125	Prespojni kabl E-2000-kompakt PC - E-2000-kompakt PC, bež/tirkiz, OM3, M/4, F8 2.7x5.5 mm, 1 m	kom	20 %	4.276,51
1068)		0000000859	R323135	Prespojni kabl E-2000-kompakt PC - E-2000-kompakt PC, bež/tirkiz, OM3, M/4, F8 2.7x5.5 mm, 2 m	kom	20 %	4.648,51

1069)		0000000860	R323136	Prespojni kabl E-2000-kompakt PC - E-2000-kompakt PC, bež/tirkiz, OM3, M/4, F8 2.7x5.5 mm, 3 m	kom	20 %	4.661,90
1070)		0000000861	R323137	Prespojni kabl E-2000-kompakt PC - E-2000-kompakt PC, bež/tirkiz, OM3, M/4, F8 2.7x5.5 mm, 5 m	kom	20 %	5.048,78
1071)		0000000862	R802518	Prespojni kabl E-2000-kompakt PC - E-2000-kompakt PC, bež/tirkiz, OM4, M/4, F8 2.7x5.5 mm, 1 m	kom	20 %	4.276,51
1072)		0000000863	R802520	Prespojni kabl E-2000-kompakt PC - E-2000-kompakt PC, bež/tirkiz, OM4, M/4, F8 2.7x5.5 mm, 2 m	kom	20 %	4.468,46
1073)		0000000864	R802521	Prespojni kabl E-2000-kompakt PC - E-2000-kompakt PC, bež/tirkiz, OM4, M/4, F8 2.7x5.5 mm, 3 m	kom	20 %	4.850,88
1074)		0000000865	R802540	Prespojni kabl E-2000-kompakt PC - E-2000-kompakt PC, bež/tirkiz, OM4, M/4, F8 2.7x5.5 mm, 5 m	kom	20 %	5.048,78

## FC



Proizvođač: Reichle &amp; De-Massari







	Web šifra	Kat.oznaka	Naziv proizvoda	Jed.mere	PDV	Cena (din)
1075)		000000866 R30907	Prespojni kabl FC APC - FC APC, G.652.D, C/1, &#216; 3.0 mm, 2 m	kom	20 %	1.705,25
1076)		000000867 R30908	Prespojni kabl FC APC - FC APC, G.652.D, C/1, &#216; 3.0 mm, 3 m	kom	20 %	1.749,89
1077)		000000868 R30910	Prespojni kabl FC APC - FC APC, G.652.D, C/1, &#216; 3.0 mm, 5 m	kom	20 %	1.840,66
1078)		000000869 R301452	Prespojni kabl FC APC - FC APC, G.652.D, C/1, &#216; 3.0 mm, 10 m	kom	20 %	2.069,81
1079)		000000870 R30902	Prespojni kabl FC PC - FC PC, G.652.D, C/2, &#216; 3.0 mm, 2 m	kom	20 %	1.949,28





1080)		0000000871 R30903	Prespojni kabl FC PC - FC PC, G.652.D, C/2, &#216; 3.0 mm, 3 m	kom	20 %	1.549,01
1081)		0000000872 R30905	Prespojni kabl FC PC - FC PC, G.652.D, C/2, &#216; 3.0 mm, 5 m	kom	20 %	1.638,29
1082)		0000000873 R301454	Prespojni kabl FC PC - FC PC, G.652.D, C/2, &#216; 3.0 mm, 10 m	kom	20 %	1.868,93

### LC

**Proizvođač: Reichle & De-Massari**

	Web šifra	Kat.oznaka	Naziv proizvoda	Jed.mere	PDV	Cena (din)
1083)		0000000874 R800981	Prespojni kabl LC APC - LC APC, zelen/zelen, G.652.D, C/1, &#216; 2.0 mm, 2 m	kom	20 %	1.907,62
1084)		0000000875 R803183	Prespojni kabl LC APC - LC APC, zelen/zelen, G.652.D, C/1, &#216; 2.0 mm, 3 m	kom	20 %	1.964,16

1085)		0000000876	R805174	Prespojni kabl LC APC - LC APC, zelen/zelen, G.652.D, C/1, &#216; 2.0 mm, 5 m	kom	20 %	1.607,04
1086)		0000000877	R805698	Prespojni kabl LC APC - LC APC, zelen/zelen, G.652.D, C/1, &#216; 3.0 mm, 2 m	kom	20 %	1.907,62
1087)		0000000878	R805699	Prespojni kabl LC APC - LC APC, zelen/zelen, G.652.D, C/1, &#216; 3.0 mm, 3 m	kom	20 %	2.068,32
1088)		0000000879	R805696	Prespojni kabl LC APC - LC APC, zelen/zelen, G.652.D, C/1, &#216; 3.0 mm, 5 m	kom	20 %	2.077,25
1089)		0000000880	R805700	Prespojni kabl LC APC - LC APC, zelen/zelen, G.657, C/1, &#216; 3.0 mm, 2 m	kom	20 %	2.011,78
1090)		0000000881	R805702	Prespojni kabl LC APC - LC APC, zelen/zelen, G.657, C/1, &#216; 3.0 mm, 3 m	kom	20 %	2.068,32

1091)		0000000882	R805703	Prespojni kabl LC APC - LC APC, zelen/zelen, G.657, C/1, &#216; 3.0 mm, 5 m	kom	20 %	2.187,36
1092)		0000000883	R805666	Prespojni kabl LC PC - LC PC, plav/plav, G.652.D, C/2, &#216; 2.0 mm, 2 m	kom	20 %	1.717,15
1093)		0000000884	R802229	Prespojni kabl LC PC - LC PC, plav/plav, G.652.D, C/2, &#216; 2.0 mm, 3 m	kom	20 %	1.773,70
1094)		0000000885	R802603	Prespojni kabl LC PC - LC PC, plav/plav, G.652.D, C/2, &#216; 2.0 mm, 5 m	kom	20 %	1.984,99

### LC dupleks

**Proizvođač: Reichle & De-Massari**

	Web šifra	Kat.oznaka	Naziv proizvoda	Jed.mere	PDV	Cena (din)	
1095)		0000000886	R805628	Prespojni kabl LC-dupleks APC - LC-dupleks APC, zelen/zelen, G.652.D, A/1, F8 2.0x4.1 mm, 2 m	kom	20 %	4.246,75

1096)		000000887	R805629	Prespojni kabl LC-dupleks APC - LC-dupleks APC, zelen/zelen, G.652.D, A/1, F8 2.0x4.1 mm, 3 m	kom	20 %	5.940,10
1097)		000000888	R805630	Prespojni kabl LC-dupleks APC - LC-dupleks APC, zelen/zelen, G.652.D, A/1, F8 2.0x4.1 mm, 5 m	kom	20 %	4.522,03
1098)		000000889	R805636	Prespojni kabl LC-dupleks APC - LC-dupleks APC, zelen/zelen, G.652.D, B/1, F8 2.0x4.1 mm, 2 m	kom	20 %	3.666,43
1099)		000000890	R805637	Prespojni kabl LC-dupleks APC - LC-dupleks APC, zelen/zelen, G.652.D, B/1, F8 2.0x4.1 mm, 3 m	kom	20 %	3.757,20
1100)		000000891	R805638	Prespojni kabl LC-dupleks APC - LC-dupleks APC, zelen/zelen, G.652.D, B/1, F8 2.0x4.1 mm, 5 m	kom	20 %	3.940,22
1101)		000000892	R308916	Prespojni kabl LC-dupleks APC - LC-dupleks APC, zelen/zelen, G.652.D, C/1, F8 2.0x4.1 mm, 2 m	kom	20 %	4.029,50

1102)		0000000893	R308917	Prespojni kabl LC-dupleks APC - LC-dupleks APC, zelen/zelen, G.652.D, C/1, F8 2.0x4.1 mm, 3 m	kom	20 %	4.148,54
1103)		0000000894	R308918	Prespojni kabl LC-dupleks APC - LC-dupleks APC, zelen/zelen, G.652.D, C/1, F8 2.0x4.1 mm, 5 m	kom	20 %	4.392,58
1104)		0000000895	R802897	Prespojni kabl LC-dupleks APC - LC-dupleks APC, zelen/zelen, G.657, C/1, F8 2.0x4.1 mm, 2 m	kom	20 %	4.029,50
1105)		0000000896	R802898	Prespojni kabl LC-dupleks APC - LC-dupleks APC, zelen/zelen, G.657, C/1, F8 2.0x4.1 mm, 3 m	kom	20 %	4.148,54
1106)		0000000897	R802901	Prespojni kabl LC-dupleks APC - LC-dupleks APC, zelen/zelen, G.657, C/1, F8 2.0x4.1 mm, 5 m	kom	20 %	4.392,58
1107)		0000000898	R805639	Prespojni kabl LC-dupleks PC - LC-dupleks PC, plav/plav, G.652.D, B/2, F8 2.0x4.1 mm, 2 m	kom	20 %	4.386,62

1108)		0000000899	R805640	Prespojni kabl LC-dupleks PC - LC-dupleks PC, plav/plav, G.652.D, B/2, F8 2.0x4.1 mm, 3 m	kom	20 %	3.467,04
1109)		0000000900	R805641	Prespojni kabl LC-dupleks PC - LC-dupleks PC, plav/plav, G.652.D, B/2, F8 2.0x4.1 mm, 5 m	kom	20 %	4.731,84
1110)		0000000901	R308903	Prespojni kabl LC-dupleks PC - LC-dupleks PC, plav/plav, G.652.D, C/2, F8 2.0x4.1 mm, 2 m	kom	20 %	3.630,72
1111)		0000000902	R308904	Prespojni kabl LC-dupleks PC - LC-dupleks PC, plav/plav, G.652.D, C/2, F8 2.0x4.1 mm, 3 m	kom	20 %	3.752,74
1112)		0000000903	R308905	Prespojni kabl LC-dupleks PC - LC-dupleks PC, plav/plav, G.652.D, C/2, F8 2.0x4.1 mm, 5 m	kom	20 %	3.996,77
1113)		0000000904	R313412	Prespojni kabl LC-dupleks PC - LC-dupleks PC, plav/plav, G.652.D, C/2, F8 2.0x4.1 mm, 10 m	kom	20 %	4.603,87

1114)		0000000905	R317465	Prespojni kabl LC-dupleks PC - LC-dupleks PC, plav/plav, G.652.D, D/3, F8 2.0x4.1 mm, 2 m	kom	20 %	2.981,95
1115)		0000000906	R316491	Prespojni kabl LC-dupleks PC - LC-dupleks PC, plav/plav, G.652.D, D/3, F8 2.0x4.1 mm, 3 m	kom	20 %	2.946,24
1116)		0000000907	R317478	Prespojni kabl LC-dupleks PC - LC-dupleks PC, plav/plav, G.652.D, D/3, F8 2.0x4.1 mm, 5 m	kom	20 %	3.175,39
1117)		0000000908	R310296	Prespojni kabl LC-dupleks PC - LC-dupleks PC, bež/plav, OM1, M/4, F8 2.0x4.1 mm, 1 m	kom	20 %	1.946,30
1118)		0000000909	R308926	Prespojni kabl LC-dupleks PC - LC-dupleks PC, bež/plav, OM1, M/4, F8 2.0x4.1 mm, 2 m	kom	20 %	3.217,06
1119)		0000000910	R308927	Prespojni kabl LC-dupleks PC - LC-dupleks PC, bež/plav, OM1, M/4, F8 2.0x4.1 mm, 3 m	kom	20 %	3.782,50





1120)		0000000911	R308928	Prespojni kabl LC-dupleks PC - LC-dupleks PC, bež/plav, OM1, M/4, F8 2.0x4.1 mm, 5 m	kom	20 %	4.910,40
1121)		0000000912	R310292	Prespojni kabl LC-dupleks PC - LC-dupleks PC, bež/oranž, OM2, M/4, F8 2.0x4.1 mm, 1 m	kom	20 %	2.371,87
1122)		0000000913	R308938	Prespojni kabl LC-dupleks PC - LC-dupleks PC, bež/oranž, OM2, M/4, F8 2.0x4.1 mm, 2 m	kom	20 %	2.651,62
1123)		0000000914	R308939	Prespojni kabl LC-dupleks PC - LC-dupleks PC, bež/oranž, OM2, M/4, F8 2.0x4.1 mm, 3 m	kom	20 %	2.160,58
1124)		0000000915	R308940	Prespojni kabl LC-dupleks PC - LC-dupleks PC, bež/oranž, OM2, M/4, F8 2.0x4.1 mm, 5 m	kom	20 %	3.493,82
1125)		0000000916	R323063	Prespojni kabl LC-dupleks PC - LC-dupleks PC, bež/tirkiz, OM3, M/4, F8 2.0x4.1 mm, 1 m	kom	20 %	2.297,47

1126)		0000000917	R323064	Prespojni kabl LC-dupleks PC - LC-dupleks PC, bež/tirkiz, OM3, M/4, F8 2.0x4.1 mm, 2 m	kom	20 %	2.502,82
1127)		0000000918	R323065	Prespojni kabl LC-dupleks PC - LC-dupleks PC, bež/tirkiz, OM3, M/4, F8 2.0x4.1 mm, 3 m	kom	20 %	2.708,16
1128)		0000000919	R323066	Prespojni kabl LC-dupleks PC - LC-dupleks PC, bež/tirkiz, OM3, M/4, F8 2.0x4.1 mm, 5 m	kom	20 %	3.121,82
1129)		0000000920	R802250	Prespojni kabl LC-dupleks PC - LC-dupleks PC, bež/tirkiz, OM4, M/4, F8 2.0x4.1 mm, 1 m	kom	20 %	2.297,47
1130)		0000000921	R802251	Prespojni kabl LC-dupleks PC - LC-dupleks PC, bež/tirkiz, OM4, M/4, F8 2.0x4.1 mm, 2 m	kom	20 %	2.502,82
1131)		0000000922	R802252	Prespojni kabl LC-dupleks PC - LC-dupleks PC, bež/tirkiz, OM4, M/4, F8 2.0x4.1 mm, 3 m	kom	20 %	2.708,16

1132)		0000000923	R802253	Prespojni kabl LC-dupleks PC - LC-dupleks PC, bež/tirkiz, OM4, M/4, F8 2.0x4.1 mm, 5 m	kom	20 %	3.121,82
-------	---	------------	---------	--	-----	------	----------

SC

Proizvođač: Reichle & De-Massari

	Web šifra	Kat.oznaka	Naziv proizvoda	Jed.mere	PDV	Cena (din)	
1133)		0000000924	R319991	Prespojni kabl SC APC - SC APC, zelen, G.652.D, A/1, &#216; 3.0 mm, 2 m	kom	20 %	1.886,78
1134)		0000000925	R319992	Prespojni kabl SC APC - SC APC, zelen, G.652.D, A/1, &#216; 3.0 mm, 3 m	kom	20 %	1.932,91
1135)		0000000926	R319850	Prespojni kabl SC APC - SC APC, zelen, G.652.D, A/1, &#216; 3.0 mm, 5 m	kom	20 %	2.023,68
1136)		0000000927	R319990	Prespojni kabl SC APC - SC APC, zelen, G.652.D, B/1, &#216; 3.0 mm, 2 m	kom	20 %	1.562,40





1137)		0000000928	R315779	Prespojni kabl SC APC - SC APC, zelen, G.652.D, B/1, &#216; 3.0 mm, 3 m	kom	20 %	1.607,04
1138)		0000000929	R313111	Prespojni kabl SC APC - SC APC, zelen, G.652.D, B/1, &#216; 3.0 mm, 5 m	kom	20 %	2.193,31
1139)		0000000930	R31026	Prespojni kabl SC APC - SC APC, zelen, G.652.D, C/1, &#216; 3.0 mm, 2 m	kom	20 %	1.601,09
1140)		0000000931	R31027	Prespojni kabl SC APC - SC APC, zelen, G.652.D, C/1, &#216; 3.0 mm, 3 m	kom	20 %	1.746,91
1141)		0000000932	R31029	Prespojni kabl SC APC - SC APC, zelen, G.652.D, C/1, &#216; 3.0 mm, 5 m	kom	20 %	1.767,74
1142)		0000000933	R301449	Prespojni kabl SC APC - SC APC, zelen, G.652.D, C/1, &#216; 3.0 mm, 10 m	kom	20 %	1.599,60

1143)		0000000934	R802899	Prespojni kabl SC APC - SC APC, zelen, G.657, C/1, &#216; 3.0 mm, 2 m	kom	20 %	1.687,39
1144)		0000000935	R802902	Prespojni kabl SC APC - SC APC, zelen, G.657, C/1, &#216; 3.0 mm, 3 m	kom	20 %	1.746,91
1145)		0000000936	R802904	Prespojni kabl SC APC - SC APC, zelen, G.657, C/1, &#216; 3.0 mm, 5 m	kom	20 %	1.865,95
1146)		0000000937	R30602	Prespojni kabl SC PC - SC PC, plav, G.652.D, C/2, &#216; 3.0 mm, 2 m	kom	20 %	1.071,36
1147)		0000000938	R30603	Prespojni kabl SC PC - SC PC, plav, G.652.D, C/2, &#216; 3.0 mm, 3 m	kom	20 %	1.443,36
1148)		0000000939	R30605	Prespojni kabl SC PC - SC PC, plav, G.652.D, C/2, &#216; 3.0 mm, 5 m	kom	20 %	1.639,78

1149)		0000000940	R301447	Prespojni kabl SC PC - SC PC, plav, G.652.D, C/2, &#216; 3.0 mm, 10 m	kom	20 %	1.836,19
-------	---	------------	---------	---	-----	------	----------

**SC dupleks**

**Proizvođač: Reichle & De-Massari**



		Web šifra	Kat.oznaka	Naziv proizvoda	Jed.mere	PDV	Cena (din)
1150)		0000000941	R303343	Prespojni kabl SC-dupleks PC - SC-dupleks PC, plav, G.652.D, C/2, F8 2.7x5.5 mm, 2 m	kom	20 %	2.931,36
1151)		0000000942	R303344	Prespojni kabl SC-dupleks PC - SC-dupleks PC, plav, G.652.D, C/2, F8 2.7x5.5 mm, 3 m	kom	20 %	3.053,38
1152)		0000000943	R303346	Prespojni kabl SC-dupleks PC - SC-dupleks PC, plav, G.652.D, C/2, F8 2.7x5.5 mm, 5 m	kom	20 %	3.297,41
1153)		0000000944	R317501	Prespojni kabl SC-dupleks PC - SC-dupleks PC, plav, G.652.D, D/3, F8 2.7x5.5 mm, 2 m	kom	20 %	1.816,85

1154)		0000000945	R316490	Prespojni kabl SC-dupleks PC - SC-dupleks PC, plav, G.652.D, D/3, F8 2.7x5.5 mm, 3 m	kom	20 %	1.909,10
1155)		0000000946	R317502	Prespojni kabl SC-dupleks PC - SC-dupleks PC, plav, G.652.D, D/3, F8 2.7x5.5 mm, 5 m	kom	20 %	2.702,21
1156)		0000000947	R303985	Prespojni kabl SC-dupleks PC - SC-dupleks PC, bež, OM1, M/4, F8 2.7x5.5 mm, 1 m	kom	20 %	2.237,95
1157)		0000000948	R303986	Prespojni kabl SC-dupleks PC - SC-dupleks PC, bež, OM1, M/4, F8 2.7x5.5 mm, 2 m	kom	20 %	2.919,46
1158)		0000000949	R303987	Prespojni kabl SC-dupleks PC - SC-dupleks PC, bež, OM1, M/4, F8 2.7x5.5 mm, 3 m	kom	20 %	3.481,92
1159)		0000000950	R303989	Prespojni kabl SC-dupleks PC - SC-dupleks PC, bež, OM1, M/4, F8 2.7x5.5 mm, 5 m	kom	20 %	3.423,89

1160)		0000000951	R303980	Prespojni kabl SC-dupleks PC - SC-dupleks PC, bež, OM2, M/4, F8 2.7x5.5 mm, 1 m	kom	20 %	2.071,30
1161)		0000000952	R303981	Prespojni kabl SC-dupleks PC - SC-dupleks PC, bež, OM2, M/4, F8 2.7x5.5 mm, 2 m	kom	20 %	2.354,02
1162)		0000000953	R303982	Prespojni kabl SC-dupleks PC - SC-dupleks PC, bež, OM2, M/4, F8 2.7x5.5 mm, 3 m	kom	20 %	2.633,76
1163)		0000000954	R303984	Prespojni kabl SC-dupleks PC - SC-dupleks PC, bež, OM2, M/4, F8 2.7x5.5 mm, 5 m	kom	20 %	3.038,50
1164)		0000000955	R323043	Prespojni kabl SC-dupleks PC - SC-dupleks PC, bež, OM3, M/4, F8 2.7x5.5 mm, 1 m	kom	20 %	1.996,90
1165)		0000000956	R323044	Prespojni kabl SC-dupleks PC - SC-dupleks PC, bež, OM3, M/4, F8 2.7x5.5 mm, 2 m	kom	20 %	2.202,24



1166)		0000000957	R800835	Prespojni kabl SC-dupleks PC - SC-dupleks PC, bež, OM3, M/4, F8 2.7x5.5 mm, 3 m	kom	20 %	2.410,56
1167)		0000000958	R323046	Prespojni kabl SC-dupleks PC - SC-dupleks PC, bež, OM3, M/4, F8 2.7x5.5 mm, 5 m	kom	20 %	2.821,25
1168)		0000000959	R802541	Prespojni kabl SC-dupleks PC - SC-dupleks PC, bež, OM4, M/4, F8 2.7x5.5 mm, 1 m	kom	20 %	1.998,38
1169)		0000000960	R802544	Prespojni kabl SC-dupleks PC - SC-dupleks PC, bež, OM4, M/4, F8 2.7x5.5 mm, 2 m	kom	20 %	2.202,24
1170)		0000000961	R802545	Prespojni kabl SC-dupleks PC - SC-dupleks PC, bež, OM4, M/4, F8 2.7x5.5 mm, 3 m	kom	20 %	2.410,56
1171)		0000000962	R802546	Prespojni kabl SC-dupleks PC - SC-dupleks PC, bež, OM4, M/4, F8 2.7x5.5 mm, 5 m	kom	20 %	2.821,25

1172)		0000000967	R502642	Prespojni kabl SC-dupleks PC - SC-dupleks PC, bež, OM3, M/4, F0 3.1x5.2 mm, 2 m	kom	20 %	3.258,72
1173)		0000000968	R502645	Prespojni kabl SC-dupleks PC - SC-dupleks PC, bež, OM3, M/4, F0 3.1x5.2 mm, 3 m	kom	20 %	3.541,44
1174)		0000000969	R502648	Prespojni kabl SC-dupleks PC - SC-dupleks PC, bež, OM3, M/4, F0 3.1x5.2 mm, 5 m	kom	20 %	4.105,39
1175)		0000000970	R502660	Prespojni kabl SC-dupleks PC - SC-dupleks PC, bež, OM3, M/4, F0 3.1x5.2 mm, 10 m	kom	20 %	5.517,50
1176)		0000000963	R802554	Prespojni kabl SC-dupleks PC - SC-dupleks PC, bež, OM4, M/4, F0 3.5x6.2 mm, 1 m	kom	20 %	1.919,52
1177)		0000000964	R802558	Prespojni kabl SC-dupleks PC - SC-dupleks PC, bež, OM4, M/4, F0 3.5x6.2 mm, 2 m	kom	20 %	2.356,99

1178)		0000000965	R802557	Prespojni kabl SC-dupleks PC - SC-dupleks PC, bež, OM4, M/4, F0 3.5x6.2 mm, 3 m	kom	20 %	2.118,91
1179)		0000000966	R802560	Prespojni kabl SC-dupleks PC - SC-dupleks PC, bež, OM4, M/4, F0 3.5x6.2 mm, 5 m	kom	20 %	2.519,18

### SC-RJ





**Proizvođač: Reichle & De-Massari**

		Web šifra	Kat.oznaka	Naziv proizvoda	Jed.mere	PDV	Cena (din)
1180)		0000000971	R320008	Prespojni kabl SC-RJ APC - SC-RJ APC, zelen, G.652.D, B/1, F8 2.7x5.5 mm, 1 m	kom	20 %	3.032,54
1181)		0000000972	R320009	Prespojni kabl SC-RJ APC - SC-RJ APC, zelen, G.652.D, B/1, F8 2.7x5.5 mm, 2 m	kom	20 %	3.123,31
1182)		0000000973	R320010	Prespojni kabl SC-RJ APC - SC-RJ APC, zelen, G.652.D, B/1, F8 2.7x5.5 mm, 3 m	kom	20 %	3.215,57

1183)		0000000974	R320011	Prespojni kabl SC-RJ APC - SC-RJ APC, zelen, G.652.D, B/1, F8 2.7x5.5 mm, 5 m	kom	20 %	3.398,59
1184)		0000000975	R319880	Prespojni kabl SC-RJ APC - SC-RJ APC, zelen, G.652.D, C/1, F8 2.7x5.5 mm, 1 m	kom	20 %	2.379,31
1185)		0000000976	R319968	Prespojni kabl SC-RJ APC - SC-RJ APC, zelen, G.652.D, C/1, F8 2.7x5.5 mm, 2 m	kom	20 %	2.470,08
1186)		0000000977	R319969	Prespojni kabl SC-RJ APC - SC-RJ APC, zelen, G.652.D, C/1, F8 2.7x5.5 mm, 3 m	kom	20 %	2.562,34
1187)		0000000978	R319970	Prespojni kabl SC-RJ APC - SC-RJ APC, zelen, G.652.D, C/1, F8 2.7x5.5 mm, 5 m	kom	20 %	2.745,36
1188)		0000000979	R319878	Prespojni kabl SC-RJ PC - SC-RJ PC, plav, G.652.D, C/2, F8 2.7x5.5 mm, 1 m	kom	20 %	2.383,78

1189)		0000000980	R319879	Prespojni kabl SC-RJ PC - SC-RJ PC, plav, G.652.D, C/2, F8 2.7x5.5 mm, 2 m	kom	20 %	2.142,72
1190)		0000000981	R319965	Prespojni kabl SC-RJ PC - SC-RJ PC, plav, G.652.D, C/2, F8 2.7x5.5 mm, 3 m	kom	20 %	2.596,56
1191)		0000000982	R319966	Prespojni kabl SC-RJ PC - SC-RJ PC, plav, G.652.D, C/2, F8 2.7x5.5 mm, 5 m	kom	20 %	2.809,34
1192)		0000000983	R317479	Prespojni kabl SC-RJ PC - SC-RJ PC, plav, G.652.D, D/3, F8 2.7x5.5 mm, 1 m	kom	20 %	2.005,82
1193)		0000000984	R317480	Prespojni kabl SC-RJ PC - SC-RJ PC, plav, G.652.D, D/3, F8 2.7x5.5 mm, 2 m	kom	20 %	2.112,96
1194)		0000000985	R317467	Prespojni kabl SC-RJ PC - SC-RJ PC, plav, G.652.D, D/3, F8 2.7x5.5 mm, 3 m	kom	20 %	2.218,61

1195)		0000000986	R317481	Prespojni kabl SC-RJ PC - SC-RJ PC, plav, G.652.D, D/3, F8 2.7x5.5 mm, 5 m	kom	20 %	2.431,39
1196)		0000000987	R319971	Prespojni kabl SC-RJ PC - SC-RJ PC, bež/plav, OM1, M/4, F8 2.7x5.5 mm, 1 m	kom	20 %	2.010,29
1197)		0000000988	R319972	Prespojni kabl SC-RJ PC - SC-RJ PC, bež/plav, OM1, M/4, F8 2.7x5.5 mm, 2 m	kom	20 %	2.153,14
1198)		0000000989	R319973	Prespojni kabl SC-RJ PC - SC-RJ PC, bež/plav, OM1, M/4, F8 2.7x5.5 mm, 3 m	kom	20 %	2.575,73
1199)		0000000990	R319974	Prespojni kabl SC-RJ PC - SC-RJ PC, bež/plav, OM1, M/4, F8 2.7x5.5 mm, 5 m	kom	20 %	3.423,89
1200)		0000000991	R319877	Prespojni kabl SC-RJ PC - SC-RJ PC, bež/oranž, OM2, M/4, F8 2.7x5.5 mm, 1 m	kom	20 %	1.766,26

1201)		0000000992	R319976	Prespojni kabl SC-RJ PC - SC-RJ PC, bež/oranž, OM2, M/4, F8 2.7x5.5 mm, 2 m	kom	20 %	2.011,78
1202)		0000000993	R319977	Prespojni kabl SC-RJ PC - SC-RJ PC, bež/oranž, OM2, M/4, F8 2.7x5.5 mm, 3 m	kom	20 %	2.258,78
1203)		0000000994	R319975	Prespojni kabl SC-RJ PC - SC-RJ PC, bež/oranž, OM2, M/4, F8 2.7x5.5 mm, 5 m	kom	20 %	2.368,90
1204)		0000000995	R323023	Prespojni kabl SC-RJ PC - SC-RJ PC, bež/tirkiz, OM3, M/4, F8 2.7x5.5 mm, 1 m	kom	20 %	1.697,81
1205)		0000000996	R323024	Prespojni kabl SC-RJ PC - SC-RJ PC, bež/tirkiz, OM3, M/4, F8 2.7x5.5 mm, 2 m	kom	20 %	2.249,86
1206)		0000000997	R323025	Prespojni kabl SC-RJ PC - SC-RJ PC, bež/tirkiz, OM3, M/4, F8 2.7x5.5 mm, 3 m	kom	20 %	2.057,90

1207)		0000000998 R323026	Prespojni kabl SC-RJ PC - SC-RJ PC, bež/tirkiz, OM3, M/4, F8 2.7x5.5 mm, 5 m	kom	20 %	2.416,51
1208)		0000000999 R802561	Prespojni kabl SC-RJ PC - SC-RJ PC, bež/tirkiz, OM4, M/4, F8 2.7x5.5 mm, 1 m	kom	20 %	2.157,60
1209)		0000001000 R802563	Prespojni kabl SC-RJ PC - SC-RJ PC, bež/tirkiz, OM4, M/4, F8 2.7x5.5 mm, 2 m	kom	20 %	2.294,50
1210)		0000001001 R802565	Prespojni kabl SC-RJ PC - SC-RJ PC, bež/tirkiz, OM4, M/4, F8 2.7x5.5 mm, 3 m	kom	20 %	2.057,90
1211)		0000001002 R802567	Prespojni kabl SC-RJ PC - SC-RJ PC, bež/tirkiz, OM4, M/4, F8 2.7x5.5 mm, 5 m	kom	20 %	2.416,51

ST

Proizvođač: Reichle & De-Massari

Web šifra	Kat.oznaka	Naziv proizvoda	Jed.mere	PDV	Cena (din)
-----------	------------	-----------------	----------	-----	------------

1212)		0000001003	R317534	Prespojni kabl ST PC 2x - ST PC 2x, G.652.D, D/3, F8 2.7x5.5 mm, 2 m	kom	20 %	3.004,27
1213)		0000001004	R317535	Prespojni kabl ST PC 2x - ST PC 2x, G.652.D, D/3, F8 2.7x5.5 mm, 3 m	kom	20 %	3.096,53
1214)		0000001005	R317536	Prespojni kabl ST PC 2x - ST PC 2x, G.652.D, D/3, F8 2.7x5.5 mm, 5 m	kom	20 %	3.279,55
1215)		0000001006	R30640	Prespojni kabl ST PC 2x - ST PC 2x, OM1, M/4, F8 2.7x5.5 mm, 1 m	kom	20 %	3.407,52
1216)		0000001007	R30641	Prespojni kabl ST PC 2x - ST PC 2x, OM1, M/4, F8 2.7x5.5 mm, 2 m	kom	20 %	3.895,58
1217)		0000001008	R30642	Prespojni kabl ST PC 2x - ST PC 2x, OM1, M/4, F8 2.7x5.5 mm, 3 m	kom	20 %	4.461,02





1218)		0000001009	R30644	Prespojni kabl ST PC 2x - ST PC 2x, OM1, M/4, F8 2.7x5.5 mm, 5 m	kom	20 %	5.588,93
1219)		0000001010	R30635	Prespojni kabl ST PC 2x - ST PC 2x, OM2, M/4, F8 2.7x5.5 mm, 1 m	kom	20 %	3.395,62
1220)		0000001011	R30636	Prespojni kabl ST PC 2x - ST PC 2x, OM2, M/4, F8 2.7x5.5 mm, 2 m	kom	20 %	3.510,19
1221)		0000001012	R30637	Prespojni kabl ST PC 2x - ST PC 2x, OM2, M/4, F8 2.7x5.5 mm, 3 m	kom	20 %	3.624,77
1222)		0000001013	R30639	Prespojni kabl ST PC 2x - ST PC 2x, OM2, M/4, F8 2.7x5.5 mm, 5 m	kom	20 %	3.964,03
1223)		0000001014	R323039	Prespojni kabl ST PC 2x - ST PC 2x, OM3, M/4, F8 2.7x5.5 mm, 1 m	kom	20 %	3.407,52

1224)		0000001015	R323040	Prespojni kabl ST PC 2x - ST PC 2x, OM3, M/4, F8 2.7x5.5 mm, 2 m	kom	20 %	3.532,51
1225)		0000001016	R323041	Prespojni kabl ST PC 2x - ST PC 2x, OM3, M/4, F8 2.7x5.5 mm, 3 m	kom	20 %	3.211,10
1226)		0000001017	R323042	Prespojni kabl ST PC 2x - ST PC 2x, OM3, M/4, F8 2.7x5.5 mm, 5 m	kom	20 %	3.603,94
1227)		0000001018	R802569	Prespojni kabl ST PC 2x - ST PC 2x, OM4, M/4, F8 2.7x5.5 mm, 1 m	kom	20 %	3.373,30
1228)		0000001019	R802571	Prespojni kabl ST PC 2x - ST PC 2x, OM4, M/4, F8 2.7x5.5 mm, 2 m	kom	20 %	3.593,52
1229)		0000001020	R802572	Prespojni kabl ST PC 2x - ST PC 2x, OM4, M/4, F8 2.7x5.5 mm, 3 m	kom	20 %	2.479,01

1230)		0000001021	R802573	Prespojni kabl ST PC 2x - ST PC 2x, OM4, M/4, F8 2.7x5.5 mm, 5 m	kom	20 %	2.788,51
-------	--	------------	---------	--	-----	------	----------

### Hibridni

Proizvođač: Reichle & De-Massari

		Web šifra	Kat.oznaka	Naziv proizvoda	Jed.mere	PDV	Cena (din)
1231)		0000001022	R303653	Prespojni kabl E-2000 APC zelen/beo - FC APC, G.652.D, C/1, &#216; 3.0 mm, 2 m	kom	20 %	2.168,02
1232)		0000001023	R303654	Prespojni kabl E-2000 APC zelen/beo - FC APC, G.652.D, C/1, &#216; 3.0 mm, 3 m	kom	20 %	2.214,14
1233)		0000001024	R303656	Prespojni kabl E-2000 APC zelen/beo - FC APC, G.652.D, C/1, &#216; 3.0 mm, 5 m	kom	20 %	2.304,91
1234)		0000001025	R308906	Prespojni kabl E-2000-kompakt PC plav/plav - LC-dupleks PC, plav/plav, G.652.D, C/2, F8 2.0x4.1 mm, 2 m	kom	20 %	4.520,54

1235)		0000001026	R308911	Prespojni kabl E-2000-kompakt PC plav/plav - LC-dupleks PC, plav/plav, G.652.D, C/2, F8 2.0x4.1 mm, 3 m	kom	20 %	4.883,62
1236)		0000001027	R308912	Prespojni kabl E-2000-kompakt PC plav/plav - LC-dupleks PC, plav/plav, G.652.D, C/2, F8 2.0x4.1 mm, 5 m	kom	20 %	5.127,65
1237)		0000001028	R317472	Prespojni kabl E-2000-kompakt PC plav/plav - LC-dupleks PC, plav/plav, G.652.D, D/3, F8 2.0x4.1 mm, 2 m	kom	20 %	3.788,45
1238)		0000001029	R317498	Prespojni kabl E-2000-kompakt PC plav/plav - LC-dupleks PC, plav/plav, G.652.D, D/3, F8 2.0x4.1 mm, 3 m	kom	20 %	3.087,60
1239)		0000001030	R317499	Prespojni kabl E-2000-kompakt PC plav/plav - LC-dupleks PC, plav/plav, G.652.D, D/3, F8 2.0x4.1 mm, 5 m	kom	20 %	3.270,62
1240)		0000001067	R303373	Prespojni kabl E-2000-kompakt APC zelen/beo - SC-dupleks APC, zelen, G.652.D, C/1, F8 2.7x5.5 mm, 2 m	kom	20 %	3.867,31

1241)		0000001068	R303374	Prespojni kabl E-2000-kompakt APC zelen/beo - SC-dupleks APC, zelen, G.652.D, C/1, F8 2.7x5.5 mm, 3 m	kom	20 %	3.958,08
1242)		0000001069	R303376	Prespojni kabl E-2000-kompakt APC zelen/beo - SC-dupleks APC, zelen, G.652.D, C/1, F8 2.7x5.5 mm, 5 m	kom	20 %	4.141,10
1243)		0000001070	R303368	Prespojni kabl E-2000-kompakt PC plav/plav - SC-dupleks PC, plav, G.652.D, C/2, F8 2.7x5.5 mm, 2 m	kom	20 %	3.522,10
1244)		0000001071	R303369	Prespojni kabl E-2000-kompakt PC plav/plav - SC-dupleks PC, plav, G.652.D, C/2, F8 2.7x5.5 mm, 3 m	kom	20 %	3.612,86
1245)		0000001072	R303371	Prespojni kabl E-2000-kompakt PC plav/plav - SC-dupleks PC, plav, G.652.D, C/2, F8 2.7x5.5 mm, 5 m	kom	20 %	4.779,46
1246)		0000001073	R317470	Prespojni kabl E-2000-kompakt PC plav/plav - SC-dupleks PC, plav, G.652.D, D/3, F8 2.7x5.5 mm, 2 m	kom	20 %	2.813,81

1247)		0000001074	R317495	Prespojni kabl E-2000-kompakt PC plav/plav - SC-dupleks PC, plav, G.652.D, D/3, F8 2.7x5.5 mm, 3 m	kom	20 %	2.906,06
1248)		0000001075	R317496	Prespojni kabl E-2000-kompakt PC plav/plav - SC-dupleks PC, plav, G.652.D, D/3, F8 2.7x5.5 mm, 5 m	kom	20 %	3.702,14
1249)		0000001076	R308913	Prespojni kabl SC-dupleks PC plav - LC-dupleks PC, plav/plav, G.652.D, C/2, F8 2.0x4.1 mm, 2 m	kom	20 %	3.279,55
1250)		0000001077	R308914	Prespojni kabl SC-dupleks PC plav - LC-dupleks PC, plav/plav, G.652.D, C/2, F8 2.0x4.1 mm, 3 m	kom	20 %	3.401,57
1251)		0000001078	R308915	Prespojni kabl SC-dupleks PC plav - LC-dupleks PC, plav/plav, G.652.D, C/2, F8 2.0x4.1 mm, 5 m	kom	20 %	3.645,60
1252)		0000001079	R317473	Prespojni kabl SC-dupleks PC plav - LC-dupleks PC, plav/plav, G.652.D, D/3, F8 2.0x4.1 mm, 2 m	kom	20 %	2.595,07

1253)		0000001080	R317504	Prespojni kabl SC-dupleks PC plav - LC-dupleks PC, plav/plav, G.652.D, D/3, F8 2.0x4.1 mm, 3 m	kom	20 %	2.090,64
1254)		0000001081	R317505	Prespojni kabl SC-dupleks PC plav - LC-dupleks PC, plav/plav, G.652.D, D/3, F8 2.0x4.1 mm, 5 m	kom	20 %	2.940,29
1255)		0000001082	R308935	Prespojni kabl SC-dupleks PC bež - LC-dupleks PC, bež/plav, OM1, M/4, F8 2.0x4.1 mm, 2 m	kom	20 %	3.068,26
1256)		0000001083	R308936	Prespojni kabl SC-dupleks PC bež - LC-dupleks PC, bež/plav, OM1, M/4, F8 2.0x4.1 mm, 3 m	kom	20 %	3.633,70
1257)		0000001084	R308937	Prespojni kabl SC-dupleks PC bež - LC-dupleks PC, bež/plav, OM1, M/4, F8 2.0x4.1 mm, 5 m	kom	20 %	4.523,52
1258)		0000001085	R308947	Prespojni kabl SC-dupleks PC bež - LC-dupleks PC, bež/oranž, OM2, M/4, F8 2.0x4.1 mm, 2 m	kom	20 %	2.377,82

1259)		0000001086	R308948	Prespojni kabl SC-dupleks PC bež - LC-dupleks PC, bež/oranž, OM2, M/4, F8 2.0x4.1 mm, 3 m	kom	20 %	2.782,56
1260)		0000001087	R308949	Prespojni kabl SC-dupleks PC bež - LC-dupleks PC, bež/oranž, OM2, M/4, F8 2.0x4.1 mm, 5 m	kom	20 %	3.345,02
1261)		0000001088	R317471	Prespojni kabl SC-RJ PC plav - LC-dupleks PC, plav/plav, G.652.D, D/3, F8 2.0x4.1 mm, 2 m	kom	20 %	1.998,38
1262)		0000001089	R317486	Prespojni kabl SC-RJ PC plav - LC-dupleks PC, plav/plav, G.652.D, D/3, F8 2.0x4.1 mm, 3 m	kom	20 %	2.090,64
1263)		0000001090	R317487	Prespojni kabl SC-RJ PC plav - LC-dupleks PC, plav/plav, G.652.D, D/3, F8 2.0x4.1 mm, 5 m	kom	20 %	2.273,66
1264)		0000001091	R308932	Prespojni kabl SC-RJ PC crn/crn - LC-dupleks PC, bež/plav, OM1, M/4, F8 2.0x4.1 mm, 2 m	kom	20 %	2.261,76

1265)		0000001092	R308933	Prespojni kabl SC-RJ PC crn/crn - LC-dupleks PC, bež/plav, OM1, M/4, F8 2.0x4.1 mm, 3 m	kom	20 %	2.685,84
1266)		0000001093	R308934	Prespojni kabl SC-RJ PC crn/crn - LC-dupleks PC, bež/plav, OM1, M/4, F8 2.0x4.1 mm, 5 m	kom	20 %	3.532,51
1267)		0000001094	R308944	Prespojni kabl SC-RJ PC crn/oranž - LC-dupleks PC, bež/oranž, OM2, M/4, F8 2.0x4.1 mm, 2 m	kom	20 %	1.840,66
1268)		0000001095	R308945	Prespojni kabl SC-RJ PC crn/oranž - LC-dupleks PC, bež/oranž, OM2, M/4, F8 2.0x4.1 mm, 3 m	kom	20 %	2.053,44
1269)		0000001096	R308946	Prespojni kabl SC-RJ PC crn/oranž - LC-dupleks PC, bež/oranž, OM2, M/4, F8 2.0x4.1 mm, 5 m	kom	20 %	2.476,03
1270)		0000001097	R30591	Prespojni kabl SC-RJ PC crn/crn - ST PC 2x, OM1, M/4, F8 2.7x5.5 mm, 1 m	kom	20 %	3.141,17

1271)		0000001098	R30592	Prespojni kabl SC-RJ PC crn/crn - ST PC 2x, OM1, M/4, F8 2.7x5.5 mm, 2 m	kom	20 %	2.507,28
1272)		0000001099	R30593	Prespojni kabl SC-RJ PC crn/crn - ST PC 2x, OM1, M/4, F8 2.7x5.5 mm, 3 m	kom	20 %	2.931,36
1273)		0000001100	R30595	Prespojni kabl SC-RJ PC crn/crn - ST PC 2x, OM1, M/4, F8 2.7x5.5 mm, 5 m	kom	20 %	3.778,03
1274)		0000001101	R300131	Prespojni kabl SC-RJ PC crn/oranž - ST PC 2x, OM2, M/4, F8 2.7x5.5 mm, 1 m	kom	20 %	2.833,15
1275)		0000001102	R300132	Prespojni kabl SC-RJ PC crn/oranž - ST PC 2x, OM2, M/4, F8 2.7x5.5 mm, 2 m	kom	20 %	2.086,18
1276)		0000001103	R300133	Prespojni kabl SC-RJ PC crn/oranž - ST PC 2x, OM2, M/4, F8 2.7x5.5 mm, 3 m	kom	20 %	2.298,96

1277)



0000001104 R300135

Prespojni kabl SC-RJ PC crn/oranž - ST PC 2x, OM2, M/4, F8  
2.7x5.5 mm, 5 m

kom

20 %

2.723,04





## Pasivne optičke komponente (PON)

### 19 inc SpliterBox

Proizvođač: Reichle & De-Massari

	Web šifra	Kat.oznaka	Naziv proizvoda	Jed.mere	PDV	Cena (din)
1278)	0000001120	R500587	19 inc 1U SpliterBox, 11 x (1 u 2), E-2000, G.652.D, APC, keramika, C/1	kom	20 %	119.804,83
1279)	0000001121	R500864	19 inc 1U SpliterBox, 11 x (1 u 2), SC, G.652.D, APC, keramika, C/1	kom	20 %	129.655,39
1280)	0000001122	R319200	19 inc 1U SpliterBox, 9 x (2 u 2), SC, G.652.D, APC, keramika, C/1	kom	20 %	101.556,00







1281)		0000001123 R319198	19 inc 1U SplitterBox, 6 x (2 u 4), SC, G.652.D, APC, keramika, C/1	kom	20 %	171.864,00
1282)		0000001124 R501152	19 inc 1U SplitterBox, 1 x (2 u 8), SC, G.652.D, APC, keramika, C/1	kom	20 %	88.140,19
1283)		0000001125 R319197	19 inc 1U SplitterBox, 3 x (2 u 8), SC, G.652.D, APC, keramika, C/1	kom	20 %	132.804,00
1284)		0000001126 R500541	19 inc 1U SplitterBox, 2 x (1 u 16), SC, G.652.D, APC, keramika, C/1	kom	20 %	167.999,66
1285)		0000001127 R319196	19 inc 1U SplitterBox, 2 x (2 u 16), SC, G.652.D, APC, keramika, C/1	kom	20 %	164.052,00
1286)		0000001128 R500533	19 inc 1U SplitterBox, 1 x (1 u 32), E-2000, G.652.D, APC, keramika, C/1	kom	20 %	172.224,10

1287)		0000001129 R500530	19 inc 1U SpliterBox, 1 x (1 u 32), SC, G.652.D, APC, keramika, C/1	kom	20 %	199.472,35
1288)		0000001130 R500528	19 inc 1U SpliterBox, 1 x (2 u 32), SC, G.652.D, APC, keramika, C/1	kom	20 %	209.444,93
1289)		0000001131 R500527	19 inc 1U SpliterBox, 1 x (1 u 64), LC, G.652.D, APC, keramika, C/1	kom	20 %	280.687,39
1290)		0000001132 R500522	19 inc 2U SpliterBox, 1 x (1 u 64), E-2000, G.652.D, APC, keramika, C/1	kom	20 %	335.916,00
1291)		0000001133 R500519	19 inc 2U SpliterBox, 1 x (1 u 64), SC, G.652.D, APC, keramika, C/1	kom	20 %	299.516,54

## Razvodni ormani i oprema

### Dodatni elementi za razvodne ormance

Proizvođač: Reichle & De-Massari

		Web šifra	Kat.oznaka	Naziv proizvoda	Jed.mere	PDV	Cena (din)
1292)		0000001114	R306179	19 inc, 1U plastični horizontalni nosač kablova, 70 mm plastični prstenovi	kom	20 %	2.739,41
1293)		0000001115	R502272	19 inc, 1U metalni horizontalni nosač kablova, 70 mm metalni prstenovi	kom	20 %	4.405,97
1294)		0000001116	R502280	19 inc, 1U metalni horizontalni nosač kablova, 90 mm metalni prstenovi	kom	20 %	4.405,97
1295)		0000001117	R306180	19 inc, 2U plastični horizontalni nosač kablova, 70 mm plastični prstenovi	kom	20 %	4.563,70
1296)		0000001118	R502281	19 inc, 2U metalni horizontalni nosač kablova, 70 mm metalni prstenovi	kom	20 %	7.984,61
1297)		0000001119	R502282	19 inc, 2U metalni horizontalni nosač kablova, 90 mm metalni prstenovi	kom	20 %	7.984,61

